

## VOLTAGE REGULATOR WITH ON/OFF SWITCH

### FEATURES

- Low Dropout Voltage
- Pass Transistor Terminals Available
- Very Low Standby Current ( ON, No Load)
- Very Low (<200 nA) Current in OFF Mode
- Low Output Noise
- Internal Thermal Shutdown
- Short Circuit Protection
- Available on Tape and Reel

### DESCRIPTION

The TK115xx series devices are low power, linear regulators with electronic ON/OFF switches. Both active HIGH and active LOW control pins are provided.

An internal PNP pass-transistor is used in order to achieve low dropout voltage (typically 200 mV at 80 mA load current). A base drive is available at pin 7 for connection of an external pass transistor should higher current (up to 1 A) or lower dropout voltage is required.

### ABSOLUTE MAXIMUM RATINGS

Supply Voltage .....	16 V
Load Current .....	180 mA
Power Dissipation (Note 1) .....	600 mW
Storage Temperature Range .....	-55 to +150 °C
Operating Temperature Range .....	-30 to +80 °C
Lead Soldering Temp. (10 sec.) .....	260 °C
Junction Temperature .....	150 °C

Note 1: Derate output power by 4.8 mW/°C for operation above 25 °C.

### APPLICATIONS

- Cordless Telephones
- Pagers
- Battery Powered Systems
- Personal Communications Equipment
- Portable Instrumentation
- Radio Control Systems
- Toys
- Low Voltage Systems
- Portable Consumer Equipment

An internal thermal shutdown circuit limits the junction temperature to below 150 °C. The load current is internally monitored, and the device will shut down in the presence of a short circuit at the output.

The TK115xx series is available in plastic surface mount SOP-8 packages.

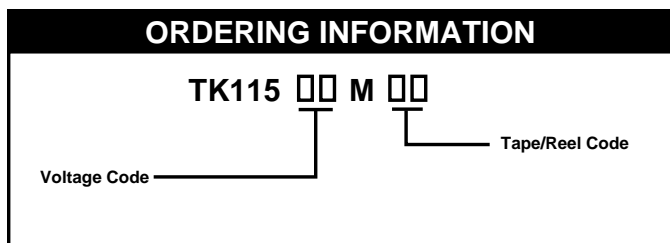
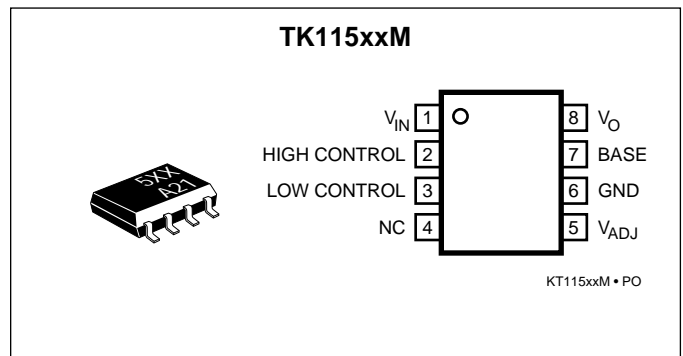

VOLTAGE CODE		TAPE/REEL CODE
30 = 3.0 V	45 = 4.5 V	BX : Bulk/Bag
32 = 3.25 V	47 = 4.75 V	TL : Tape Left
35 = 3.5 V	50 = 5.0 V	MG: Magazine
37 = 3.75 V	55 = 5.5 V	
40 = 4.0 V	80 = 8.0 V	

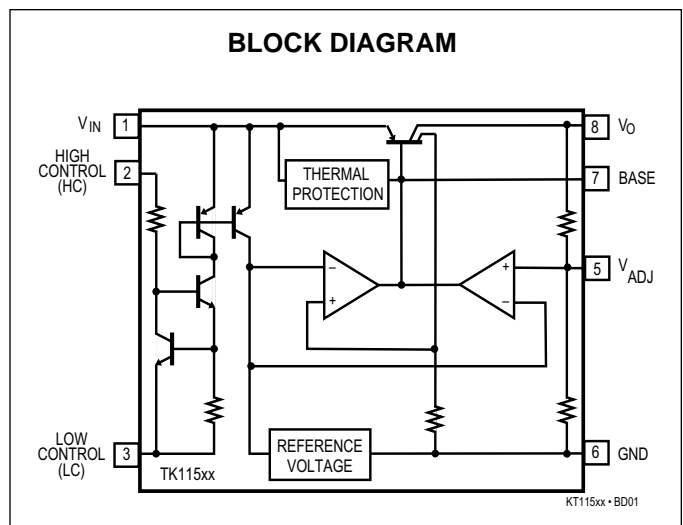

# TK115xx

TEST CIRCUIT 1

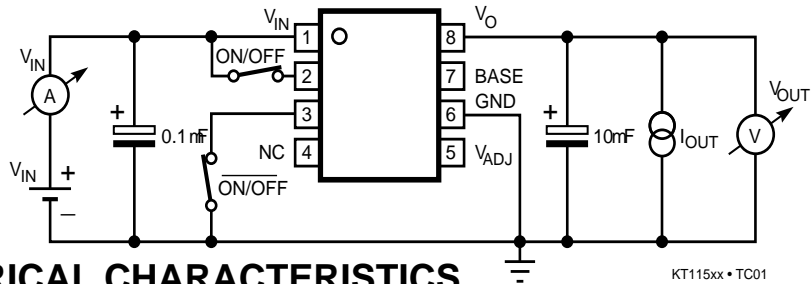

## TK11530 ELECTRICAL CHARACTERISTICS

KT115xx • TC01

SYMBOL	PARAMETER	TEST CONDITIONS	MIN	TYP	MAX	UNITS
$I_{CC1}$	Supply Current 1	$V_{IN} = 4.0 \text{ V}, I_O = 0 \text{ mA}$		500	900	$\mu\text{A}$
$I_{CC2}$	Supply Current 2	$V_{IN} = 2.5 \text{ V}, I_O = 0 \text{ mA}$		1.4	2.5	$\text{mA}$
$I_{CCS}$	Standby Supply Current	$V_{IN} = 14 \text{ V}, \text{Output Off}$		0.2	2.0	$\mu\text{A}$
$V_O$	Output Voltage	$V_{IN} = 4.0 \text{ V}, I_O = 30 \text{ mA}$	2.9	3.0	3.1	$\text{V}$
$V_{DROP}$	Voltage Dropout	$I_O = 60 \text{ mA}$		0.13	0.35	$\text{V}$
$I_O$	Output Current	$V_O = 2.7 \text{ V}$	100	130		$\text{mA}$
$I_{OR}$	Recommended Output Current				100	$\text{mA}$
LinReg	Line Regulation	$V_{IN} = 4\text{V} \rightarrow 9 \text{ V}$		5.0	30	$\text{mV}$
LoaReg	Load Regulation	$I_O = 0 \text{ to } 30 \text{ mA}, V_{IN} = 4.0 \text{ V}$ (Note 1)		18	50	$\text{mV}$
		$I_O = 0 \text{ to } 60 \text{ mA}, V_{IN} = 4.0 \text{ V}$ (Note 1)		36	80	$\text{mV}$
RR	Ripple Regulation	100 $\text{mV}_{\text{rms}}$ , $f = 400 \text{ Hz}$ , $V_{IN} = 4.5 \text{ V}, I_O = 10 \text{ mA}$		55		$\text{dB}$
$\Delta V_O / \Delta T_A$	$V_O$ Temperature Coefficient	$V_{IN} = 4.5 \text{ V}, I_O = 10 \text{ mA}$ , $-20 \text{ }^\circ\text{C} \leq T_A \leq 75 \text{ }^\circ\text{C}$		$\pm 0.3$		$\text{mV}/^\circ\text{C}$
$V_{NO}$	Output Noise Voltage	$10 \text{ Hz} \leq f \leq 100 \text{ kHz}, I_O = 10 \text{ mA}$		180		$\mu\text{V}_{\text{rms}}$
$I_B$	Base Terminal Current	$V_{IN} = 4.0 \text{ V}$	6	14	35	$\text{mA}$
Active High Control Terminal						
$I_{HC}$	HC Terminal Current	Output On, Connect LC & GND		2	40	$\mu\text{A}$
$V_{HC1}$	HC Terminal Voltage 1	Output On, Connect LC & GND	2.4		$V_{IN}$	$\text{V}$
$V_{HC2}$	HC Terminal Voltage 2	Output Off, Connect LC & GND	0		0.6	$\text{V}$
Active Low Control Terminal						
$I_{LC}$	LC Terminal Current	Output On, Connect HC & GND		35	120	$\mu\text{A}$
$V_{LC1}$	LC Terminal Voltage 1	Output On, Connect HC & GND	0		$V_{IN} - 2.5$	$\text{V}$
$V_{LC2}$	LC Terminal Voltage 2	Output Off, Connect HC & GND	$V_{IN} - 0.2$		$V_{IN}$	$\text{V}$

Note 1: This is a pulse measurement where  $T_J$  is constant. The output change due to temperature is not included.

## TK11532 ELECTRICAL CHARACTERISTICS

SYMBOL	PARAMETER	TEST CONDITIONS	MIN	TYP	MAX	UNITS
$I_{CC1}$	Supply Current 1	$V_{IN} = 4.2 \text{ V}$ , $I_O = 0 \text{ mA}$		500	900	$\mu\text{A}$
$I_{CC2}$	Supply Current 2	$V_{IN} = 2.5 \text{ V}$ , $I_O = 0 \text{ mA}$		1.4	2.5	mA
$I_{CCS}$	Standby Supply Current	$V_{IN} = 14 \text{ V}$ , Output Off		0.2	2.0	$\mu\text{A}$
$V_O$	Output Voltage	$V_{IN} = 4.2 \text{ V}$ , $I_O = 30 \text{ mA}$	3.15	3.25	3.35	V
$V_{DROP}$	Voltage Dropout	$I_O = 60 \text{ mA}$		0.13	0.35	V
$I_O$	Output Current	$V_O = 2.95 \text{ V}$	100	130		mA
$I_{OR}$	Recommended Output Current				100	mA
LinReg	Line Regulation	$V_{IN} = 4.2 \text{ V} \rightarrow 9.2 \text{ V}$		6.0	30	mV
LoaReg	Load Regulation	$I_O = 0 \text{ to } 30 \text{ mA}$ , $V_{IN} = 4.2 \text{ V}$ (Note 1)		20	50	mV
		$I_O = 0 \text{ to } 60 \text{ mA}$ , $V_{IN} = 4.2 \text{ V}$ (Note 1)		40	80	mV
RR	Ripple Regulation	100 mVrms, $f = 400 \text{ Hz}$ , $V_{IN} = 4.7 \text{ V}$ , $I_O = 10 \text{ mA}$		55		dB
$\Delta V_O / \Delta T_A$	$V_O$ Temperature Coefficient	$V_{IN} = 4.7 \text{ V}$ , $I_O = 10 \text{ mA}$ , $-20 \text{ }^\circ\text{C} \leq T_A \leq 75 \text{ }^\circ\text{C}$		$\pm 0.3$		mV/ $^\circ\text{C}$
$V_{NO}$	Output Noise Voltage	10 Hz $\leq f \leq$ 100 kHz, $I_O = 10 \text{ mA}$		180		$\mu\text{Vrms}$
$I_B$	Base Terminal Current	$V_{IN} = 4.2 \text{ V}$	6	14	35	mA
Active High Control Terminal						
$I_{HC}$	HC Terminal Current	Output On, Connect LC & GND		2	40	$\mu\text{A}$
$V_{HC1}$	HC Terminal Voltage 1	Output On, Connect LC & GND	2.4		$V_{IN}$	V
$V_{HC2}$	HC Terminal Voltage 2	Output Off, Connect LC & GND	0		0.6	V
Active Low Control Terminal						
$I_{LC}$	LC Terminal Current	Output On, Connect HC & GND		35	120	$\mu\text{A}$
$V_{LC1}$	LC Terminal Voltage 1	Output On, Connect HC & GND	0		$V_{IN}-2.5$	V
$V_{LC2}$	LC Terminal Voltage 2	Output Off, Connect HC & GND	$V_{IN}-0.2$		$V_{IN}$	V

Note 1: This is a pulse measurement where  $T_j$  is constant. The output change due to temperature is not included.

## TK11535 ELECTRICAL CHARACTERISTICS

SYMBOL	PARAMETER	TEST CONDITIONS	MIN	TYP	MAX	UNITS
$I_{CC1}$	Supply Current 1	$V_{IN} = 4.5\text{ V}$ , $I_O = 0\text{ mA}$		500	900	$\mu\text{A}$
$I_{CC2}$	Supply Current 2	$V_{IN} = 2.5\text{ V}$ , $I_O = 0\text{ mA}$		1.4	2.5	mA
$I_{CCS}$	Standby Supply Current	$V_{IN} = 14\text{ V}$ , Output Off		0.2	2.0	$\mu\text{A}$
$V_O$	Output Voltage	$V_{IN} = 4.5\text{ V}$ , $I_O = 30\text{ mA}$	3.38	3.5	3.62	V
$V_{DROP}$	Voltage Dropout	$I_O = 60\text{ mA}$		0.13	0.35	V
$I_O$	Output Current	$V_O = 3.2\text{ V}$	100	130		mA
$I_{OR}$	Recommended Output Current				100	mA
LinReg	Line Regulation	$V_{IN} = 4.5\text{ V} \rightarrow 9.5\text{ V}$		6.0	30	mV
LoaReg	Load Regulation	$I_O = 0\text{ to }30\text{ mA}$ , $V_{IN} = 4.5\text{ V}$ (Note 1)		20	55	mV
		$I_O = 0\text{ to }60\text{ mA}$ , $V_{IN} = 4.5\text{ V}$ (Note 1)		40	95	mV
RR	Ripple Regulation	100 mVrms, $f = 400\text{ Hz}$ , $V_{IN} = 5.0\text{ V}$ , $I_O = 10\text{ mA}$		55		dB
$\Delta V_O/\Delta T_A$	$V_O$ Temperature Coefficient	$V_{IN} = 5.0\text{ V}$ , $I_O = 10\text{ mA}$ , $-20\text{ }^\circ\text{C} \leq T_A \leq 75\text{ }^\circ\text{C}$		$\pm 0.3$		mV/ $^\circ\text{C}$
$V_{NO}$	Output Noise Voltage	10 Hz $\leq f \leq$ 100 kHz, $I_O = 10\text{ mA}$		180		$\mu\text{Vrms}$
$I_B$	Base Terminal Current	$V_{IN} = 4.5\text{ V}$	6	14	35	mA
Active High Control Terminal						
$I_{HC}$	HC Terminal Current	Output On, Connect LC & GND		2	40	$\mu\text{A}$
$V_{HC1}$	HC Terminal Voltage 1	Output On, Connect LC & GND	2.4		$V_{IN}$	V
$V_{HC2}$	HC Terminal Voltage 2	Output Off, Connect LC & GND	0		0.6	V
Active Low Control Terminal						
$I_{LC}$	LC Terminal Current	Output On, Connect HC & GND		35	120	$\mu\text{A}$
$V_{LC1}$	LC Terminal Voltage 1	Output On, Connect HC & GND	0		$V_{IN}-2.5$	V
$V_{LC2}$	LC Terminal Voltage 2	Output Off, Connect HC & GND	$V_{IN}-0.2$		$V_{IN}$	V

Note 1: This is a pulse measurement where  $T_j$  is constant. The output change due to temperature is not included.

## TK11537 ELECTRICAL CHARACTERISTICS

SYMBOL	PARAMETER	TEST CONDITIONS	MIN	TYP	MAX	UNITS
$I_{CC1}$	Supply Current 1	$V_{IN} = 4.75 \text{ V}$ , $I_O = 0 \text{ mA}$		500	900	$\mu\text{A}$
$I_{CC2}$	Supply Current 2	$V_{IN} = 3.3 \text{ V}$ , $I_O = 0 \text{ mA}$		1.4	2.5	$\text{mA}$
$I_{CCS}$	Standby Supply Current	$V_{IN} = 14 \text{ V}$ , Output Off		0.2	2.0	$\mu\text{A}$
$V_O$	Output Voltage	$V_{IN} = 4.75 \text{ V}$ , $I_O = 30 \text{ mA}$	3.625	3.75	3.88	$\text{V}$
$V_{DROP}$	Voltage Dropout	$I_O = 60 \text{ mA}$		0.13	0.35	$\text{V}$
$I_O$	Output Current	$V_O = 3.45 \text{ V}$	100	130		$\text{mA}$
$I_{OR}$	Recommended Output Current				100	$\text{mA}$
LinReg	Line Regulation	$V_{IN} = 4.75 \text{ V} \rightarrow 9.75 \text{ V}$		6.0	30	$\text{mV}$
LoaReg	Load Regulation	$I_O = 0 \text{ to } 30 \text{ mA}$ , $V_{IN} = 4.75 \text{ V}$ (Note 1)		20	55	$\text{mV}$
		$I_O = 0 \text{ to } 60 \text{ mA}$ , $V_{IN} = 4.75 \text{ V}$ (Note 1)		40	95	$\text{mV}$
RR	Ripple Regulation	100 mVrms, $f = 400 \text{ Hz}$ , $V_{IN} = 5.25 \text{ V}$ , $I_O = 10 \text{ mA}$		55		$\text{dB}$
$\Delta V_O / \Delta T_A$	$V_O$ Temperature Coefficient	$V_{IN} = 5.25 \text{ V}$ , $I_O = 10 \text{ mA}$ , $-20 \text{ }^\circ\text{C} \leq T_A \leq 75 \text{ }^\circ\text{C}$		$\pm 0.3$		$\text{mV}/^\circ\text{C}$
$V_{NO}$	Output Noise Voltage	$10 \text{ Hz} \leq f \leq 100 \text{ kHz}$ , $I_O = 10 \text{ mA}$		180		$\mu\text{Vrms}$
$I_B$	Base Terminal Current	$V_{IN} = 4.75 \text{ V}$	6	14	35	$\text{mA}$
Active High Control Terminal						
$I_{HC}$	HC Terminal Current	Output On, Connect LC & GND		2	40	$\mu\text{A}$
$V_{HC1}$	HC Terminal Voltage 1	Output On, Connect LC & GND	2.4		$V_{IN}$	$\text{V}$
$V_{HC2}$	HC Terminal Voltage 2	Output Off, Connect LC & GND	0		0.6	$\text{V}$
Active Low Control Terminal						
$I_{LC}$	LC Terminal Current	Output On, Connect HC & GND		35	120	$\mu\text{A}$
$V_{LC1}$	LC Terminal Voltage 1	Output On, Connect HC & GND	0		$V_{IN}-2.5$	$\text{V}$
$V_{LC2}$	LC Terminal Voltage 2	Output Off, Connect HC & GND	$V_{IN}-0.2$		$V_{IN}$	$\text{V}$

Note 1: This is a pulse measurement where  $T_j$  is constant. The output change due to temperature is not included.

## TK11540 ELECTRICAL CHARACTERISTICS

SYMBOL	PARAMETER	TEST CONDITIONS	MIN	TYP	MAX	UNITS
$I_{CC1}$	Supply Current 1	$V_{IN} = 5.0\text{ V}, I_O = 0\text{ mA}$		500	900	$\mu\text{A}$
$I_{CC2}$	Supply Current 2	$V_{IN} = 3.0\text{ V}, I_O = 0\text{ mA}$		1.4	2.5	mA
$I_{CCS}$	Standby Supply Current	$V_{IN} = 14\text{ V}, \text{Output Off}$		0.2	2.0	$\mu\text{A}$
$V_O$	Output Voltage	$V_{IN} = 5.0\text{ V}, I_O = 30\text{ mA}$	3.88	4.0	4.12	V
$V_{DROP}$	Voltage Dropout	$I_O = 60\text{ mA}$		0.13	0.35	V
$I_O$	Output Current	$V_O = 3.7\text{ V}$	100	130		mA
$I_{OR}$	Recommended Output Current				100	mA
LinReg	Line Regulation	$V_{IN} = 5.0\text{ V} \rightarrow 10.0\text{ V}$		8.0	40	mV
LoaReg	Load Regulation	$I_O = 0\text{ to }30\text{ mA}, V_{IN} = 5.0\text{ V}$ (Note 1)		24	60	mV
		$I_O = 0\text{ to }60\text{ mA}, V_{IN} = 5.0\text{ V}$ (Note 1)		48	100	mV
RR	Ripple Regulation	100 mVrms, $f = 400\text{ Hz}$ , $V_{IN} = 5.5\text{ V}, I_O = 10\text{ mA}$		55		dB
$\Delta V_O / \Delta T_A$	$V_O$ Temperature Coefficient	$V_{IN} = 5.5\text{ V}, I_O = 10\text{ mA}$ , $-20\text{ }^\circ\text{C} \leq T_A \leq 75\text{ }^\circ\text{C}$		$\pm 0.4$		mV/ $^\circ\text{C}$
$V_{NO}$	Output Noise Voltage	10 Hz $\leq f \leq$ 100 kHz, $I_O = 10\text{ mA}$		180		$\mu\text{Vrms}$
$I_B$	Base Terminal Current	$V_{IN} = 5.0\text{ V}$	6	14	35	mA
Active High Control Terminal						
$I_{HC}$	HC Terminal Current	Output On, Connect LC & GND		2	40	$\mu\text{A}$
$V_{HC1}$	HC Terminal Voltage 1	Output On, Connect LC & GND	2.4		$V_{IN}$	V
$V_{HC2}$	HC Terminal Voltage 2	Output Off, Connect LC & GND	0		0.6	V
Active Low Control Terminal						
$I_{LC}$	LC Terminal Current	Output On, Connect HC & GND		35	120	$\mu\text{A}$
$V_{LC1}$	LC Terminal Voltage 1	Output On, Connect HC & GND	0		$V_{IN}-2.5$	V
$V_{LC2}$	LC Terminal Voltage 2	Output Off, Connect HC & GND	$V_{IN}-0.2$		$V_{IN}$	V

Note 1: This is a pulse measurement where  $T_j$  is constant. The output change due to temperature is not included.

## TK11545 ELECTRICAL CHARACTERISTICS

SYMBOL	PARAMETER	TEST CONDITIONS	MIN	TYP	MAX	UNITS
$I_{CC1}$	Supply Current 1	$V_{IN} = 5.5 \text{ V}$ , $I_O = 0 \text{ mA}$		500	900	$\mu\text{A}$
$I_{CC2}$	Supply Current 2	$V_{IN} = 3.5 \text{ V}$ , $I_O = 0 \text{ mA}$		1.4	2.5	mA
$I_{CCS}$	Standby Supply Current	$V_{IN} = 14 \text{ V}$ , Output Off		0.2	2.0	$\mu\text{A}$
$V_O$	Output Voltage	$V_{IN} = 5.5 \text{ V}$ , $I_O = 30 \text{ mA}$	4.36	4.5	4.64	V
$V_{DROP}$	Voltage Dropout	$I_O = 60 \text{ mA}$		0.13	0.35	V
$I_O$	Output Current	$V_O = 4.2 \text{ V}$	100	130		mA
$I_{OR}$	Recommended Output Current				100	mA
LinReg	Line Regulation	$V_{IN} = 5.5 \text{ V} \rightarrow 10.5 \text{ V}$		8.0	40	mV
LoaReg	Load Regulation	$I_O = 0 \text{ to } 30 \text{ mA}$ , $V_{IN} = 5.5 \text{ V}$ (Note 1)		25	65	mV
		$I_O = 0 \text{ to } 60 \text{ mA}$ , $V_{IN} = 5.5 \text{ V}$ (Note 1)		55	110	mV
RR	Ripple Regulation	100 mVrms, $f = 400 \text{ Hz}$ , $V_{IN} = 6.0 \text{ V}$ , $I_O = 10 \text{ mA}$		55		dB
$\Delta V_O / \Delta T_A$	$V_O$ Temperature Coefficient	$V_{IN} = 6.0 \text{ V}$ , $I_O = 10 \text{ mA}$ , $-20 \text{ }^\circ\text{C} \leq T_A \leq 75 \text{ }^\circ\text{C}$		$\pm 0.5$		mV/ $^\circ\text{C}$
$V_{NO}$	Output Noise Voltage	10 Hz $\leq f \leq$ 100 kHz, $I_O = 10 \text{ mA}$		180		$\mu\text{Vrms}$
$I_B$	Base Terminal Current	$V_{IN} = 5.5 \text{ V}$	6	14	35	mA
Active High Control Terminal						
$I_{HC}$	HC Terminal Current	Output On, Connect LC & GND		2	40	$\mu\text{A}$
$V_{HC1}$	HC Terminal Voltage 1	Output On, Connect LC & GND	2.4		$V_{IN}$	V
$V_{HC2}$	HC Terminal Voltage 2	Output Off, Connect LC & GND	0		0.6	V
Active Low Control Terminal						
$I_{LC}$	LC Terminal Current	Output On, Connect HC & GND		35	120	$\mu\text{A}$
$V_{LC1}$	LC Terminal Voltage 1	Output On, Connect HC & GND	0		$V_{IN}-2.5$	V
$V_{LC2}$	LC Terminal Voltage 2	Output Off, Connect HC & GND	$V_{IN}-0.2$		$V_{IN}$	V

Note 1: This is a pulse measurement where  $T_j$  is constant. The output change due to temperature is not included.

## TK11547 ELECTRICAL CHARACTERISTICS

SYMBOL	PARAMETER	TEST CONDITIONS	MIN	TYP	MAX	UNITS
$I_{CC1}$	Supply Current 1	$V_{IN} = 5.7 \text{ V}$ , $I_O = 0 \text{ mA}$		500	900	$\mu\text{A}$
$I_{CC2}$	Supply Current 2	$V_{IN} = 3.7 \text{ V}$ , $I_O = 0 \text{ mA}$		1.4	2.5	mA
$I_{CCS}$	Standby Supply Current	$V_{IN} = 14 \text{ V}$ , Output Off		0.2	2.0	$\mu\text{A}$
$V_O$	Output Voltage	$V_{IN} = 5.7 \text{ V}$ , $I_O = 30 \text{ mA}$	4.6	4.75	4.9	V
$V_{DROP}$	Voltage Dropout	$I_O = 60 \text{ mA}$		0.13	0.35	V
$I_O$	Output Current	$V_O = 4.45 \text{ V}$	100	130		mA
$I_{OR}$	Recommended Output Current				100	mA
LinReg	Line Regulation	$V_{IN} = 5.7 \text{ V} \rightarrow 10.7 \text{ V}$		8.0	40	mV
LoaReg	Load Regulation	$I_O = 0 \text{ to } 30 \text{ mA}$ , $V_{IN} = 5.7 \text{ V}$ (Note 1)		25	70	mV
		$I_O = 0 \text{ to } 60 \text{ mA}$ , $V_{IN} = 5.7 \text{ V}$ (Note 1)		50	120	mV
RR	Ripple Regulation	100 mVrms, $f = 400 \text{ Hz}$ , $V_{IN} = 6.2 \text{ V}$ , $I_O = 10 \text{ mA}$		55		dB
$\Delta V_O / \Delta T_A$	$V_O$ Temperature Coefficient	$V_{IN} = 6.2 \text{ V}$ , $I_O = 10 \text{ mA}$ , $-20 \text{ }^\circ\text{C} \leq T_A \leq 75 \text{ }^\circ\text{C}$		$\pm 0.6$		mV/ $^\circ\text{C}$
$V_{NO}$	Output Noise Voltage	10 Hz $\leq f \leq$ 100 kHz, $I_O = 10 \text{ mA}$		180		$\mu\text{Vrms}$
$I_B$	Base Terminal Current	$V_{IN} = 5.7 \text{ V}$	6	14	35	mA
Active High Control Terminal						
$I_{HC}$	HC Terminal Current	Output On, Connect LC & GND		2	40	$\mu\text{A}$
$V_{HC1}$	HC Terminal Voltage 1	Output On, Connect LC & GND	2.4		$V_{IN}$	V
$V_{HC2}$	HC Terminal Voltage 2	Output Off, Connect LC & GND	0		0.6	V
Active Low Control Terminal						
$I_{LC}$	LC Terminal Current	Output On, Connect HC & GND		35	120	$\mu\text{A}$
$V_{LC1}$	LC Terminal Voltage 1	Output On, Connect HC & GND	0		$V_{IN}-2.5$	V
$V_{LC2}$	LC Terminal Voltage 2	Output Off, Connect HC & GND	$V_{IN}-0.2$		$V_{IN}$	V

Note 1: This is a pulse measurement where  $T_j$  is constant. The output change due to temperature is not included.



## TK11550 ELECTRICAL CHARACTERISTICS

SYMBOL	PARAMETER	TEST CONDITIONS	MIN	TYP	MAX	UNITS
$I_{CC1}$	Supply Current 1	$V_{IN} = 6.0\text{ V}$ , $I_O = 0\text{ mA}$		500	900	$\mu\text{A}$
$I_{CC2}$	Supply Current 2	$V_{IN} = 4.0\text{ V}$ , $I_O = 0\text{ mA}$		1.4	2.5	mA
$I_{CCS}$	Standby Supply Current	$V_{IN} = 14\text{ V}$ , Output Off		0.2	2.0	$\mu\text{A}$
$V_O$	Output Voltage	$V_{IN} = 6.0\text{ V}$ , $I_O = 30\text{ mA}$ , $T_A = 25\text{ }^\circ\text{C}$	4.85	5.0	5.15	V
$V_{DROP}$	Voltage Dropout	$I_O = 60\text{ mA}$		0.13	0.35	V
$I_O$	Output Current	$V_O = 4.7\text{ V}$	100	130		mA
$I_{OR}$	Recommended Output Current				100	mA
LinReg	Line Regulation	$V_{IN} = 6.0\text{ V} \rightarrow 11\text{ V}$		8.0	40	mV
LoaReg	Load Regulation	$I_O = 0\text{ to }30\text{ mA}$ , $V_{IN} = 6.0\text{ V}$ (Note 1)		25	70	mV
		$I_O = 0\text{ to }60\text{ mA}$ , $V_{IN} = 6.0\text{ V}$ (Note 1)		50	120	mV
RR	Ripple Regulation	100 mVrms, $f = 400\text{ Hz}$ , $V_{IN} = 6.5\text{ V}$ , $I_O = 10\text{ mA}$		55		dB
$\Delta V_O/\Delta T_A$	$V_O$ Temperature Coefficient	$V_{IN} = 6.5\text{ V}$ , $I_O = 10\text{ mA}$ , $-20\text{ }^\circ\text{C} \leq T_A \leq 75\text{ }^\circ\text{C}$		$\pm 0.6$		mV/ $^\circ\text{C}$
$V_{NO}$	Output Noise Voltage	10 Hz $\leq f \leq$ 100 kHz, $I_O = 10\text{ mA}$		180		$\mu\text{Vrms}$
$I_B$	Base Terminal Current	$V_{IN} = 6.0\text{ V}$	6	14	35	mA
Active High Control Terminal						
$I_{HC}$	HC Terminal Current	Output On, Connect LC & GND		2	40	$\mu\text{A}$
$V_{HC1}$	HC Terminal Voltage 1	Output On, Connect LC & GND	2.4		$V_{IN}$	V
$V_{HC2}$	HC Terminal Voltage 2	Output Off, Connect LC & GND	0		0.6	V
Active Low Control Terminal						
$I_{LC}$	LC Terminal Current	Output On, Connect HC & GND		35	120	$\mu\text{A}$
$V_{LC1}$	LC Terminal Voltage 1	Output On, Connect HC & GND	0		$V_{IN}-2.5$	V
$V_{LC2}$	LC Terminal Voltage 2	Output Off, Connect HC & GND	$V_{IN}-0.2$		$V_{IN}$	V

Note 1: This is a pulse measurement where  $T_j$  is constant. The output change due to temperature is not included.

## TK11555 ELECTRICAL CHARACTERISTICS

SYMBOL	PARAMETER	TEST CONDITIONS	MIN	TYP	MAX	UNITS
$I_{CC1}$	Supply Current 1	$V_{IN} = 6.5 \text{ V}, I_O = 0 \text{ mA}$		500	900	$\mu\text{A}$
$I_{CC2}$	Supply Current 2	$V_{IN} = 4.5 \text{ V}, I_O = 0 \text{ mA}$		1.4	2.5	mA
$I_{CCS}$	Standby Supply Current	$V_{IN} = 14 \text{ V}, \text{Output Off}$		0.2	2.0	$\mu\text{A}$
$V_O$	Output Voltage	$V_{IN} = 6.5 \text{ V}, I_O = 30 \text{ mA}$	5.225	5.5	5.665	V
$V_{DROP}$	Voltage Dropout	$I_O = 60 \text{ mA}$		0.13	0.35	V
$I_O$	Output Current	$V_O = 5.2 \text{ V}$	100	130		mA
$I_{OR}$	Recommended Output Current				100	mA
LinReg	Line Regulation	$V_{IN} = 6.5 \text{ V} \rightarrow 11.5 \text{ V}$		8.0	40	mV
LoaReg	Load Regulation	$I_O = 0 \text{ to } 30 \text{ mA}, V_{IN} = 6.5 \text{ V}$ (Note 1)		25	70	mV
		$I_O = 0 \text{ to } 60 \text{ mA}, V_{IN} = 6.5 \text{ V}$ (Note 1)		50	120	mV
RR	Ripple Regulation	100 mVrms, $f = 400 \text{ Hz}$ , $V_{IN} = 7.0 \text{ V}, I_O = 10 \text{ mA}$		55		dB
$\Delta V_O / \Delta T_A$	$V_O$ Temperature Coefficient	$V_{IN} = 7.0 \text{ V}, I_O = 10 \text{ mA}$ , $-20 \text{ }^\circ\text{C} \leq T_A \leq 75 \text{ }^\circ\text{C}$		$\pm 0.6$		mV/ $^\circ\text{C}$
$V_{NO}$	Output Noise Voltage	10 Hz $\leq f \leq$ 100 kHz, $I_O = 10 \text{ mA}$		180		$\mu\text{Vrms}$
$I_B$	Base Terminal Current	$V_{IN} = 6.5 \text{ V}$	6	14	35	mA
Active High Control Terminal						
$I_{HC}$	HC Terminal Current	Output On, Connect LC & GND		2	40	$\mu\text{A}$
$V_{HC1}$	HC Terminal Voltage 1	Output On, Connect LC & GND	2.4		$V_{IN}$	V
$V_{HC2}$	HC Terminal Voltage 2	Output Off, Connect LC & GND	0		0.6	V
Active Low Control Terminal						
$I_{LC}$	LC Terminal Current	Output On, Connect HC & GND		35	120	$\mu\text{A}$
$V_{LC1}$	LC Terminal Voltage 1	Output On, Connect HC & GND	0		$V_{IN}-2.5$	V
$V_{LC2}$	LC Terminal Voltage 2	Output Off, Connect HC & GND	$V_{IN}-0.2$		$V_{IN}$	V

Note 1: This is a pulse measurement where  $T_j$  is constant. The output change due to temperature is not included.

## TK11580 ELECTRICAL CHARACTERISTICS

SYMBOL	PARAMETER	TEST CONDITIONS	MIN	TYP	MAX	UNITS
$I_{CC1}$	Supply Current 1	$V_{IN} = 9.0\text{ V}$ , $I_O = 0\text{ mA}$		500	900	$\mu\text{A}$
$I_{CC2}$	Supply Current 2	$V_{IN} = 7.0\text{ V}$ , $I_O = 0\text{ mA}$		1.4	2.5	mA
$I_{CCS}$	Standby Supply Current	$V_{IN} = 14\text{ V}$ , Output Off		0.2	2.0	$\mu\text{A}$
$V_O$	Output Voltage	$V_{IN} = 9.0\text{ V}$ , $I_O = 30\text{ mA}$	7.76	8.0	8.24	V
$V_{DROP}$	Voltage Dropout	$I_O = 60\text{ mA}$		0.13	0.35	V
$I_O$	Output Current	$V_O = 7.7\text{ V}$	100	130		mA
$I_{OR}$	Recommended Output Current				100	mA
LinReg	Line Regulation	$V_{IN} = 9.0\text{ V} \rightarrow 14.0\text{ V}$		16.0	40	mV
LoaReg	Load Regulation	$I_O = 0\text{ to }30\text{ mA}$ , $V_{IN} = 9.0\text{ V}$ (Note 1)		35	110	mV
		$I_O = 0\text{ to }60\text{ mA}$ , $V_{IN} = 9.0\text{ V}$ (Note 1)		70	200	mV
RR	Ripple Regulation	100 mVrms, $f = 400\text{ Hz}$ , $V_{IN} = 9.5\text{ V}$ , $I_O = 10\text{ mA}$		55		dB
$\Delta V_O / \Delta T_A$	$V_O$ Temperature Coefficient	$V_{IN} = 9.5\text{ V}$ , $I_O = 10\text{ mA}$ , $-20\text{ }^\circ\text{C} \leq T_A \leq 75\text{ }^\circ\text{C}$		$\pm 1.0$		mV/ $^\circ\text{C}$
$V_{NO}$	Output Noise Voltage	10 Hz $\leq f \leq$ 100 kHz, $I_O = 10\text{ mA}$		180		$\mu\text{Vrms}$
$I_B$	Base Terminal Current	$V_{IN} = 9.0\text{ V}$	6	14	35	mA
Active High Control Terminal						
$I_{HC}$	HC Terminal Current	Output On, Connect LC & GND		2	40	$\mu\text{A}$
$V_{HC1}$	HC Terminal Voltage 1	Output On, Connect LC & GND	2.4		$V_{IN}$	V
$V_{HC2}$	HC Terminal Voltage 2	Output Off, Connect LC & GND	0		0.6	V
Active Low Control Terminal						
$I_{LC}$	LC Terminal Current	Output On, Connect HC & GND		35	120	$\mu\text{A}$
$V_{LC1}$	LC Terminal Voltage 1	Output On, Connect HC & GND	0		$V_{IN}-2.5$	V
$V_{LC2}$	LC Terminal Voltage 2	Output Off, Connect HC & GND	$V_{IN}-0.2$		$V_{IN}$	V

Note 1: This is a pulse measurement where  $T_j$  is constant. The output change due to temperature is not included.

## TYPICAL PERFORMANCE CHARACTERISTICS

### COMMON CHARACTERISTICS

$T_A = 25^\circ\text{C}$  unless otherwise specified

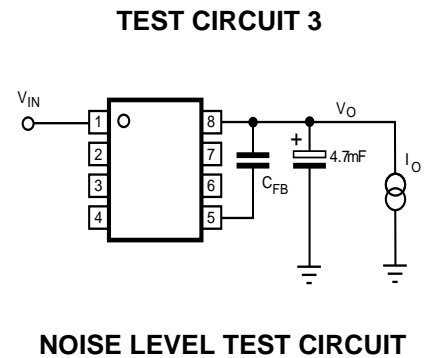
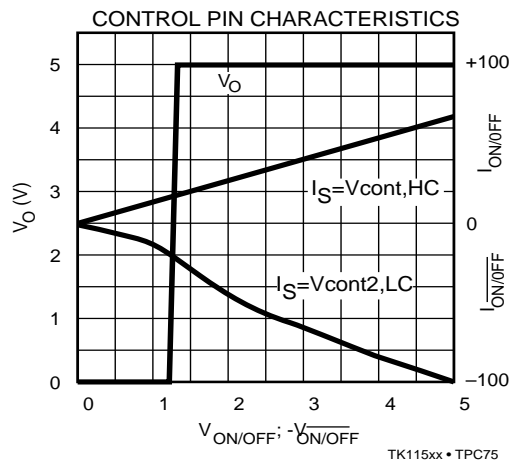
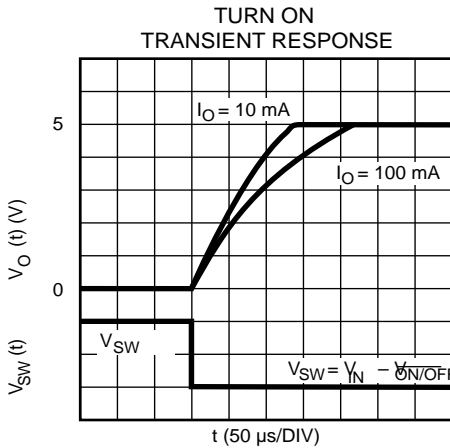
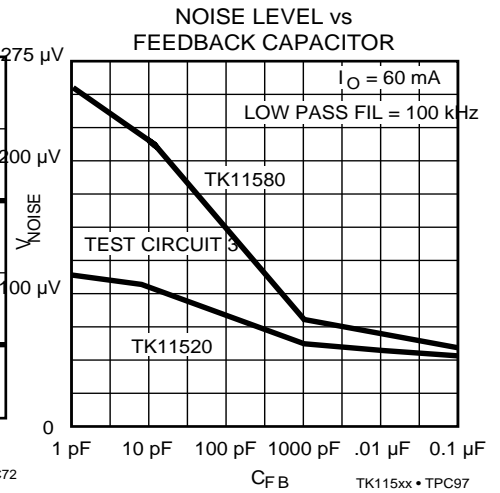
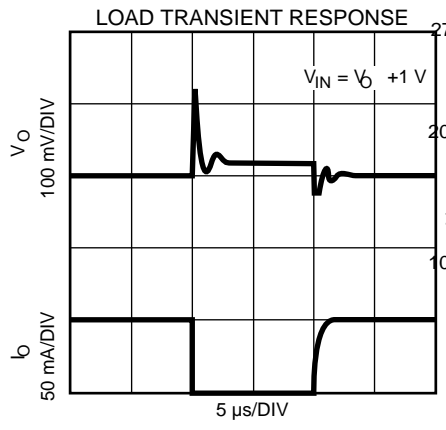
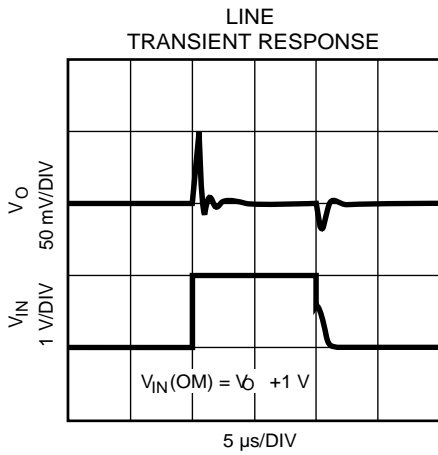
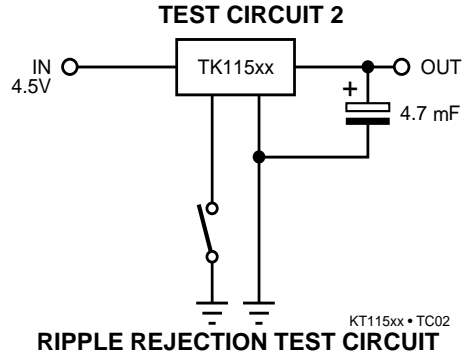
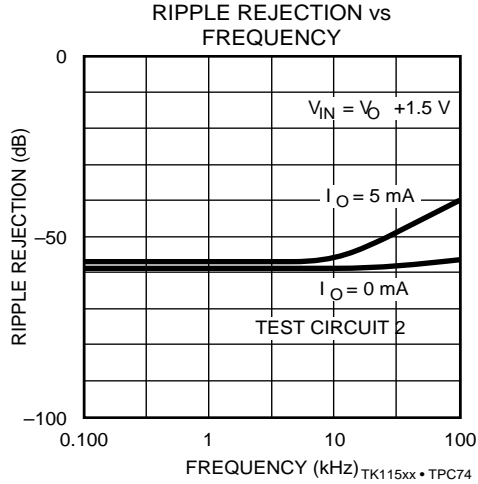

## COMMON CHARACTERISTICS WITH EXTERNAL CURRENT BOOST TRANSISTOR (NEC 2SA733 OR TOSHIBA 2SA1244)

$T_A = 25\text{ }^\circ\text{C}$  unless otherwise specified

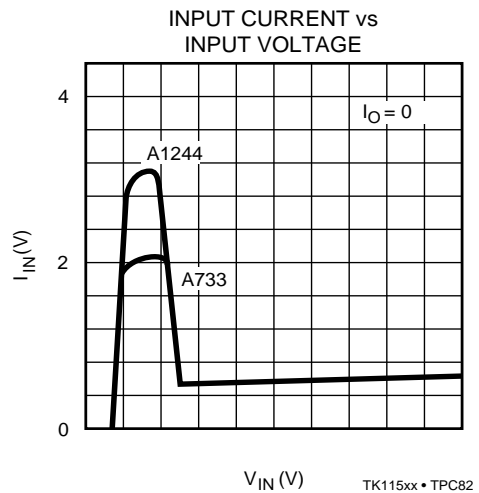
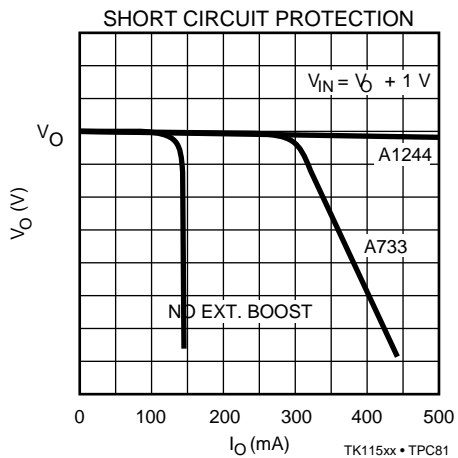
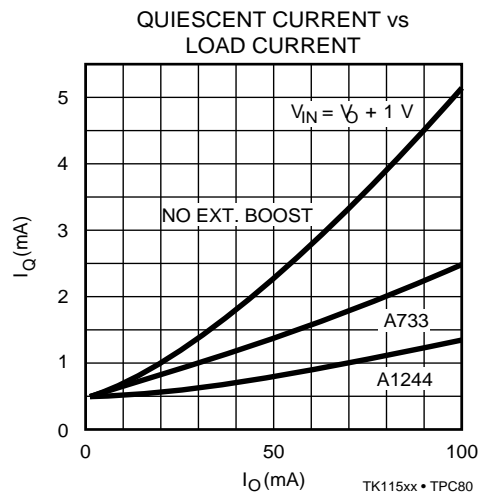
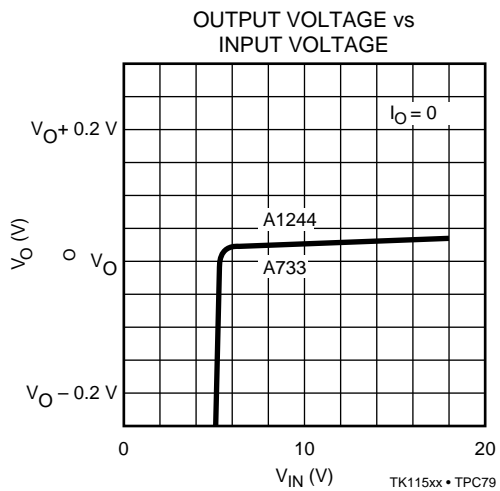
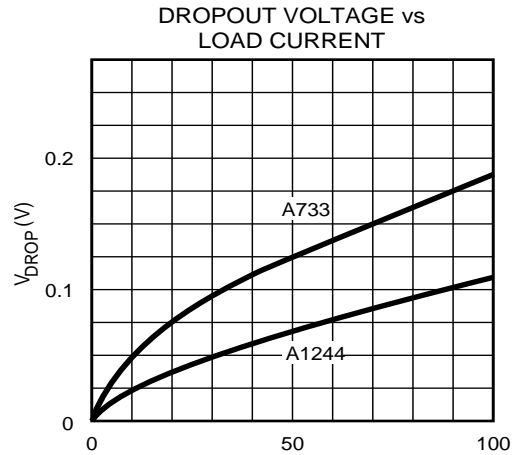
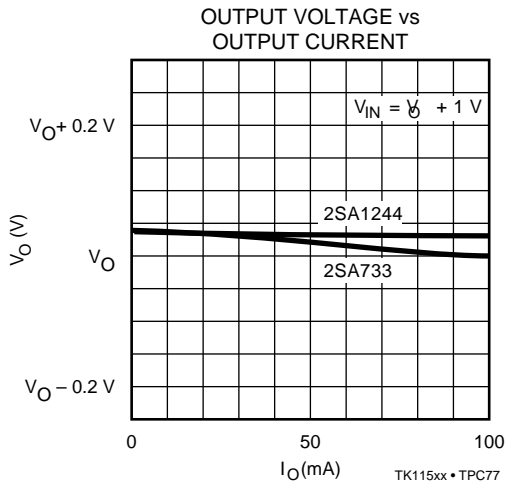

## VOLTAGE ADJUSTMENT

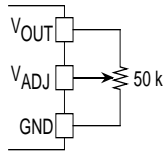

For large adjustment range use a 50 K potentiometer. This method gives good results when a voltage lower than the rated output is needed.

For small changes in output voltage use R1 to increase the output voltage or R2 to decrease the output voltage. The graph at right shows the approximate resistance values. The initial output voltage is indicated on the graph. (3 V = TK11530 etc.)

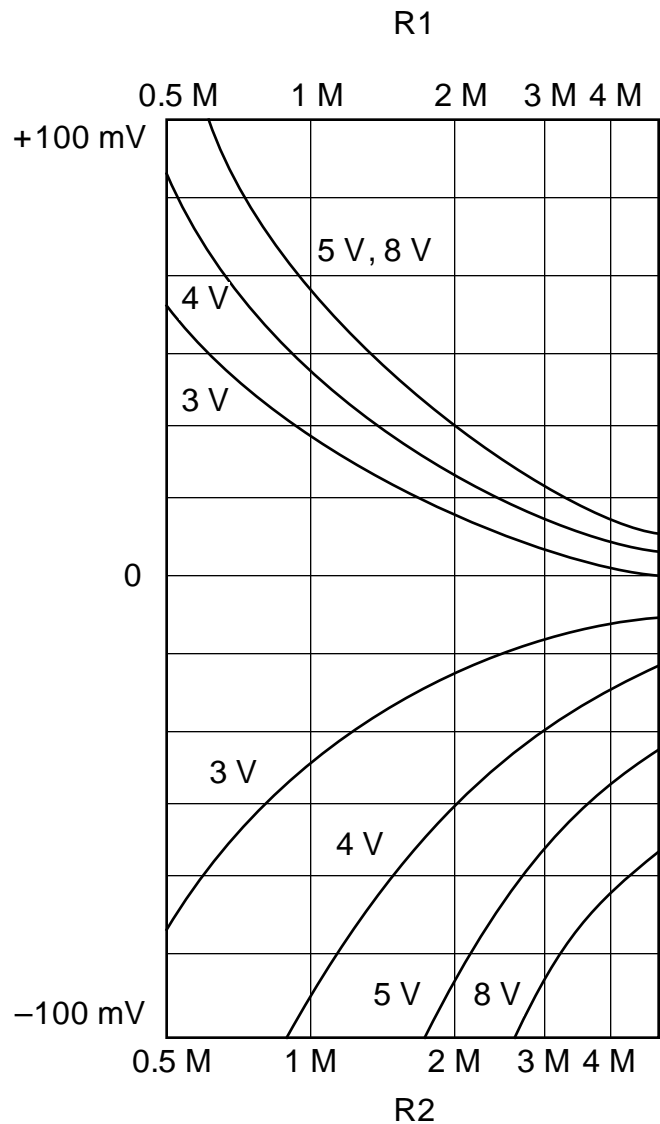
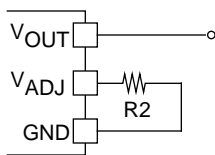
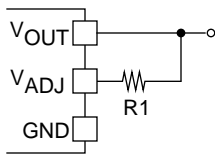

$T_A = 25\text{ }^\circ\text{C}$  unless otherwise specified

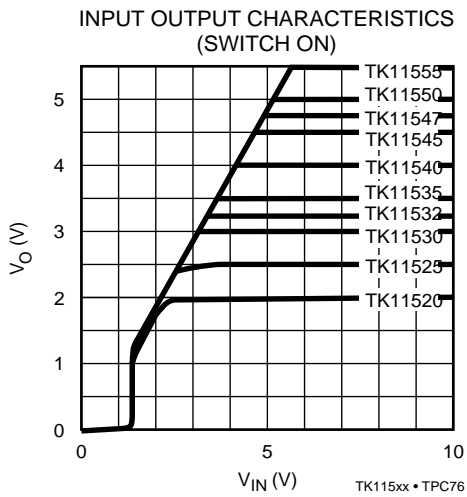
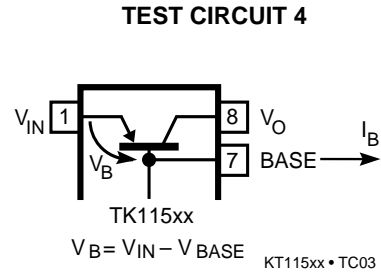
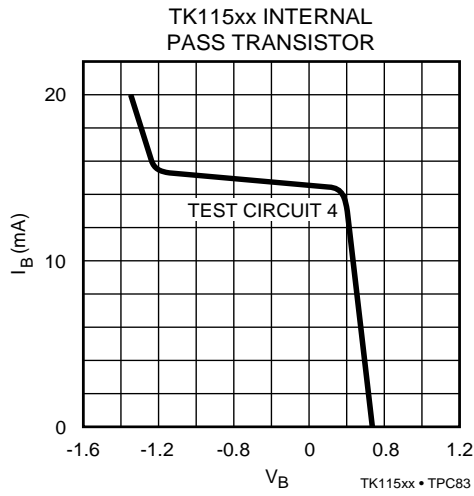

## TYPICAL PERFORMANCE CHARACTERISTICS (CONT.)

### TEMPERATURE CHARACTERISTICS

$T_A = 25^\circ\text{C}$  unless otherwise specified

TK11530  
OUTPUT VOLTAGE vs  
TEMPERATURE

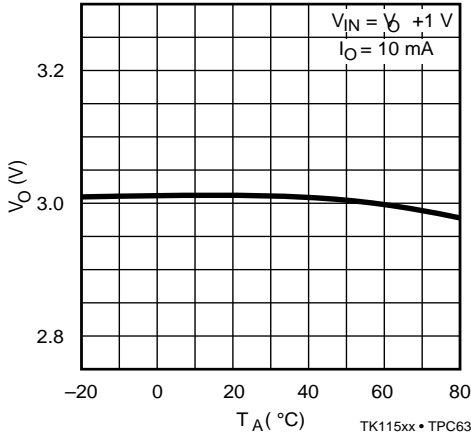

TK11532  
OUTPUT VOLTAGE vs  
TEMPERATURE

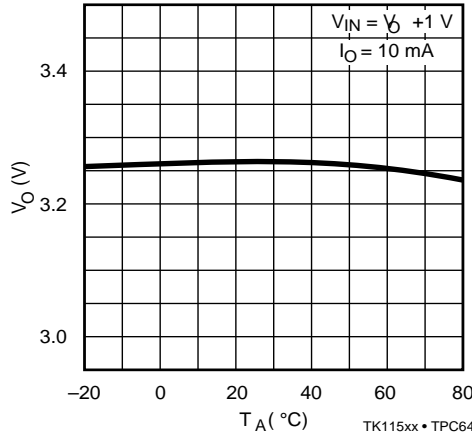

TK11535  
OUTPUT VOLTAGE vs  
TEMPERATURE

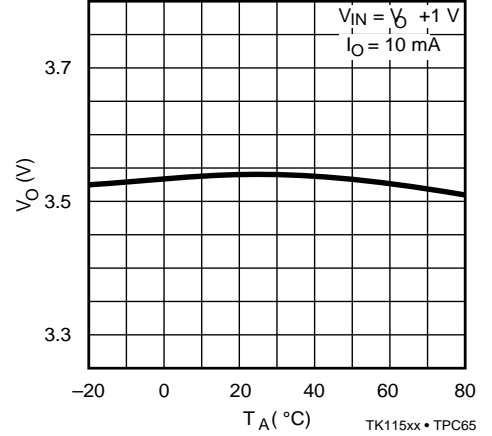

TK11537  
OUTPUT VOLTAGE vs  
TEMPERATURE

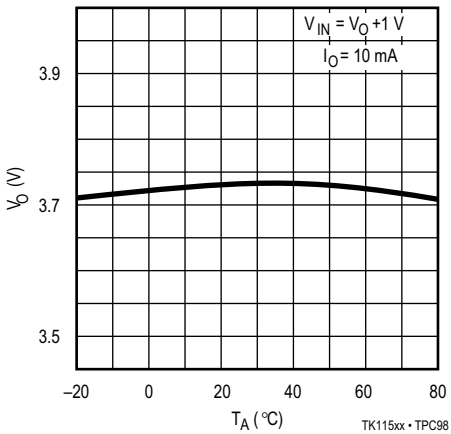

TK11540  
OUTPUT VOLTAGE vs  
TEMPERATURE

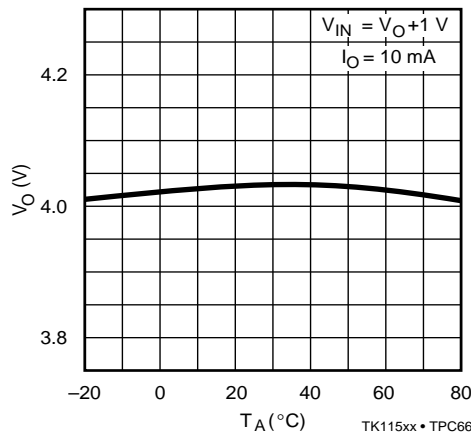

TK11545  
OUTPUT VOLTAGE vs  
TEMPERATURE

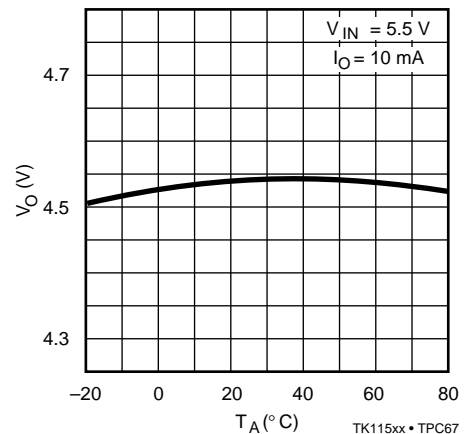

TK11547  
OUTPUT VOLTAGE vs  
TEMPERATURE

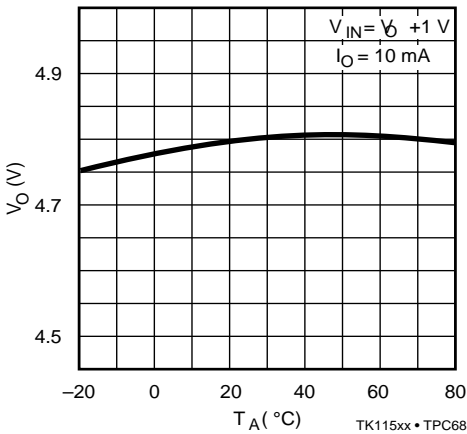

TK11550  
OUTPUT VOLTAGE vs  
TEMPERATURE

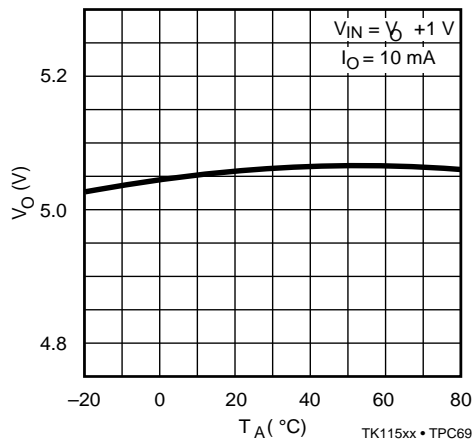

TK11555  
OUTPUT VOLTAGE vs  
TEMPERATURE

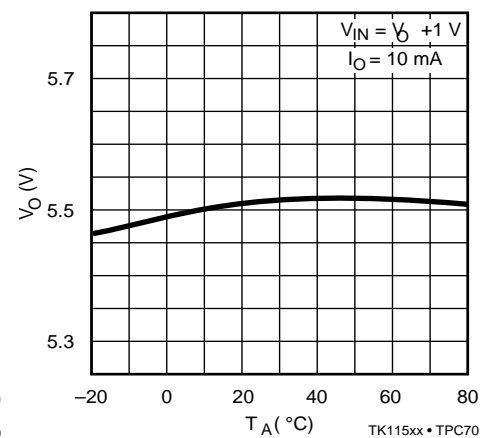



TYPICAL PERFORMANCE CHARACTERISTICS (CONT.)

TEMPERATURE CHARACTERISTICS (CONT.)

$T_A = 25\text{ }^\circ\text{C}$  unless otherwise specified

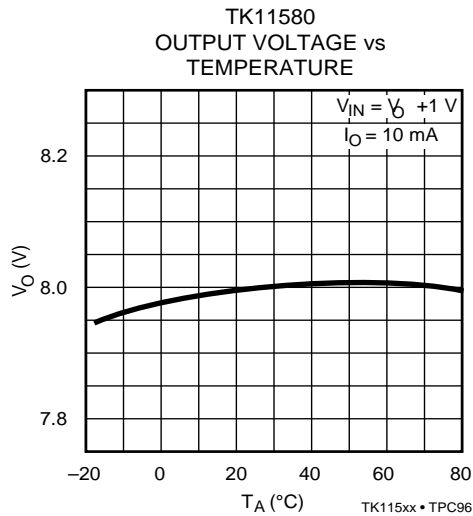

TK11530

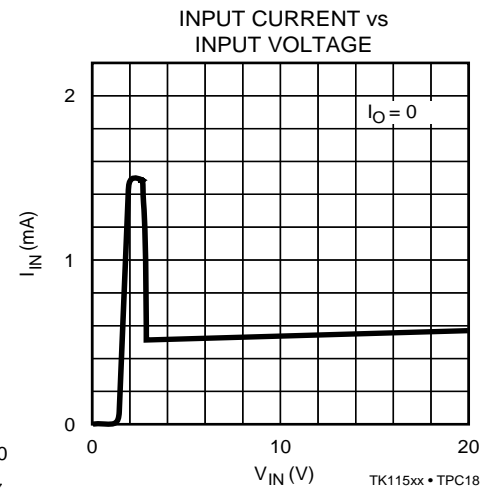
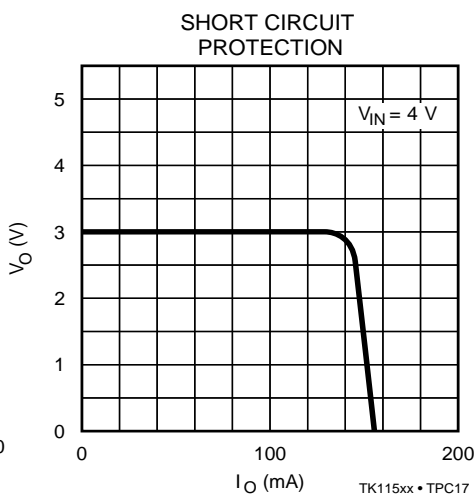
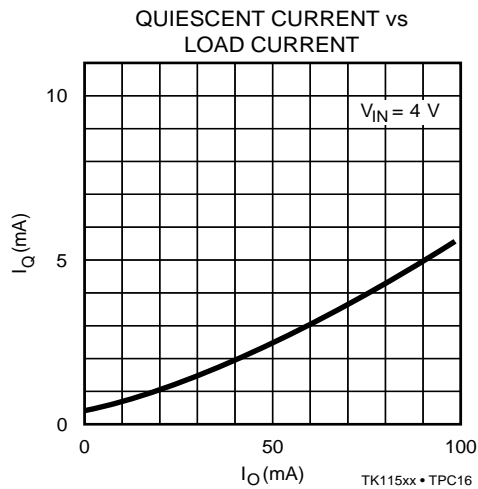
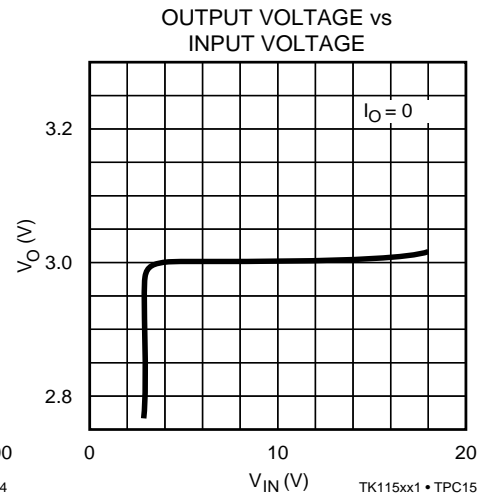
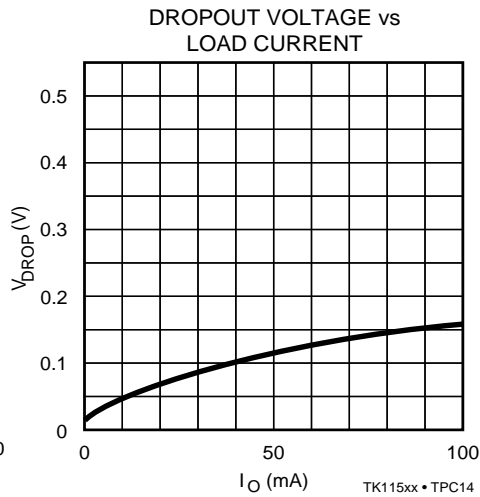
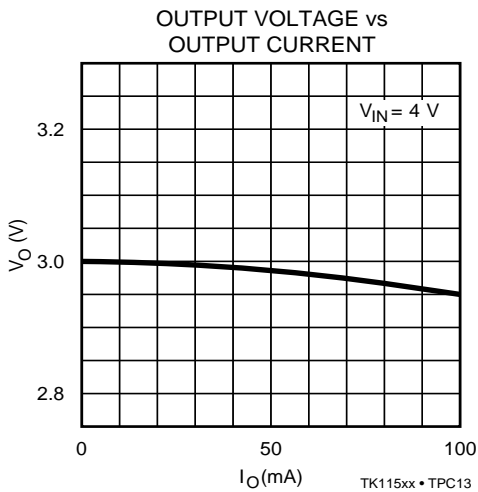

## TYPICAL PERFORMANCE CHARACTERISTICS (CONT.)

TK11532

$T_A = 25\text{ }^\circ\text{C}$  unless otherwise specified

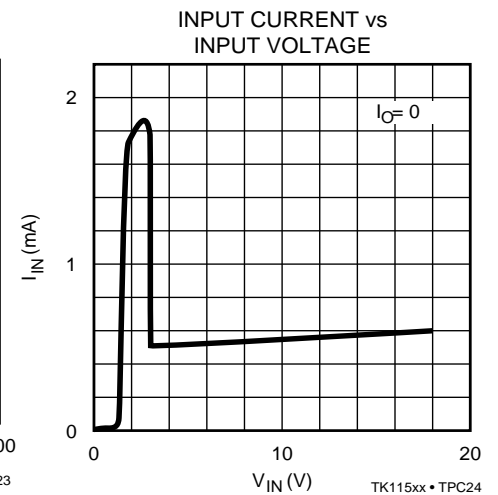
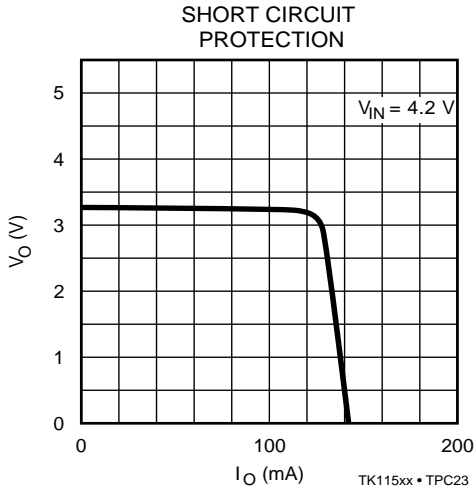
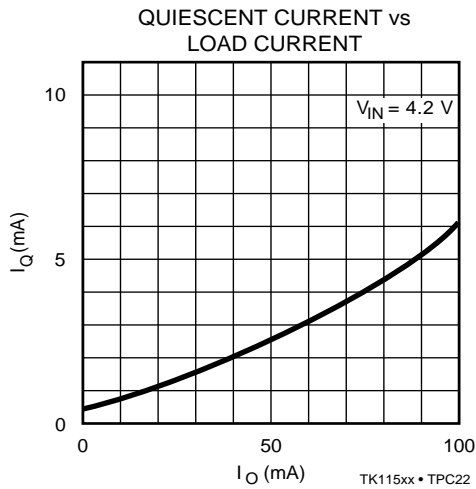
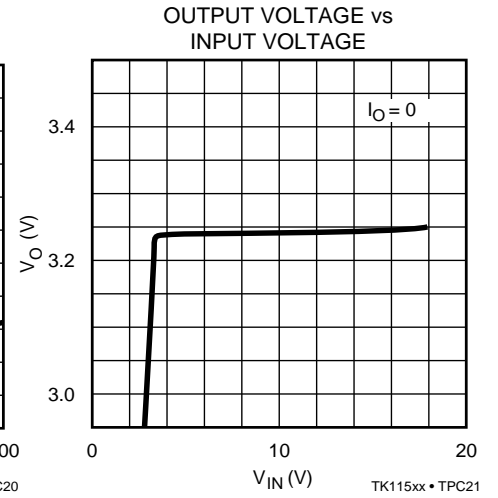
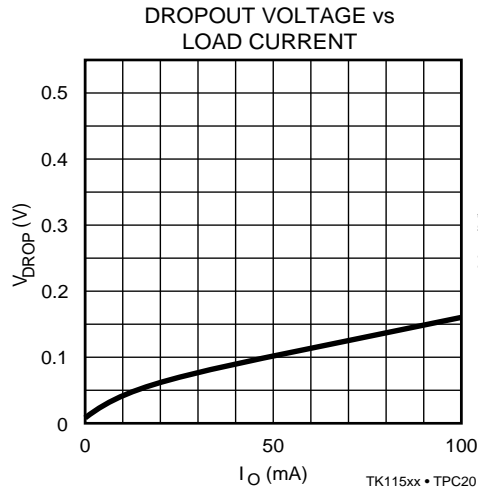
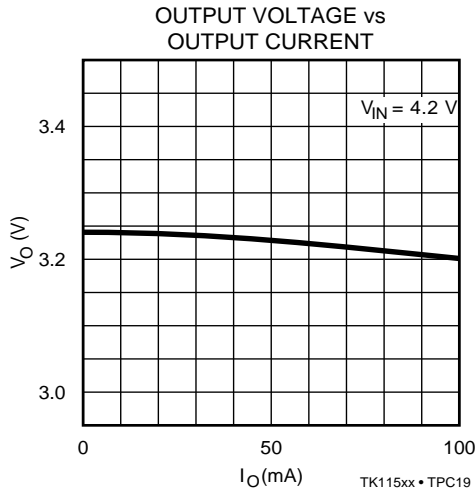

TK11535

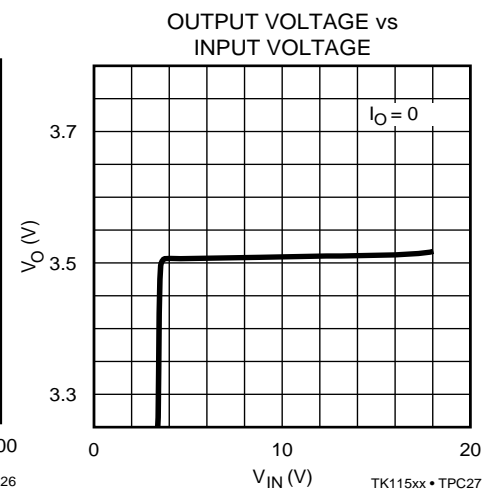
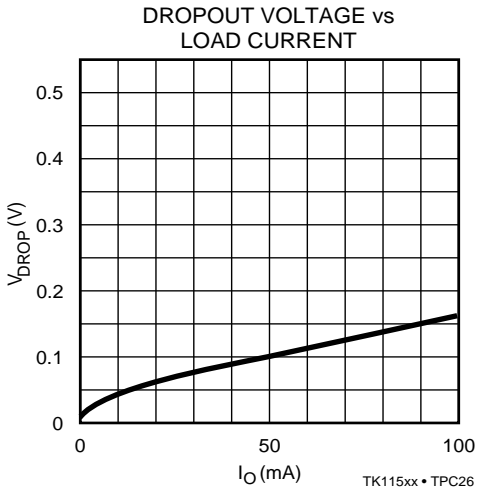
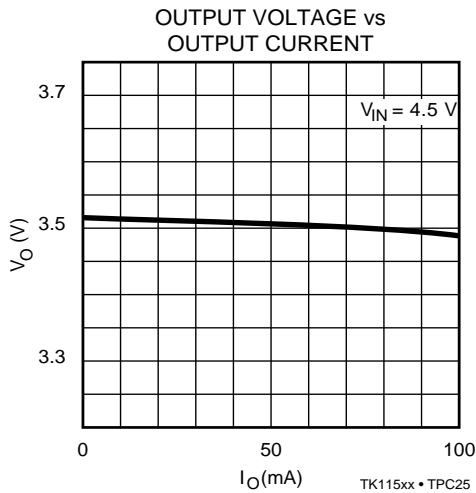

TYPICAL PERFORMANCE CHARACTERISTICS (CONT.)

TK11535 (CONT.)

$T_A = 25\text{ }^\circ\text{C}$  unless otherwise specified

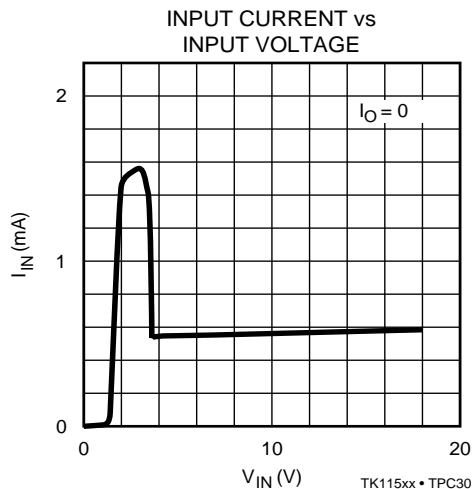
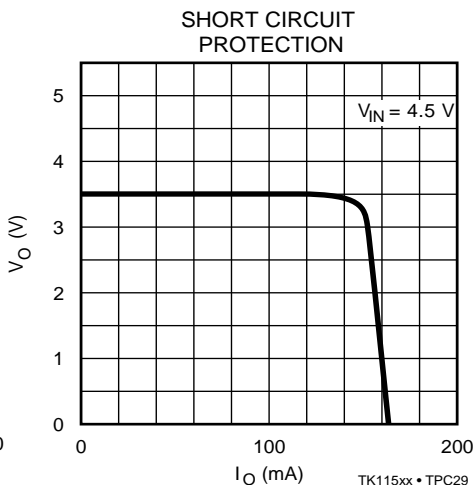
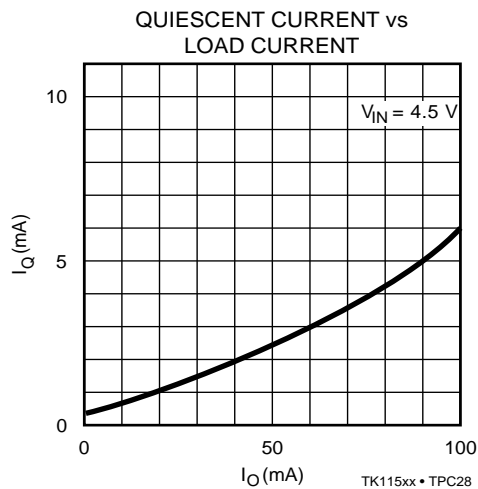

TK11537

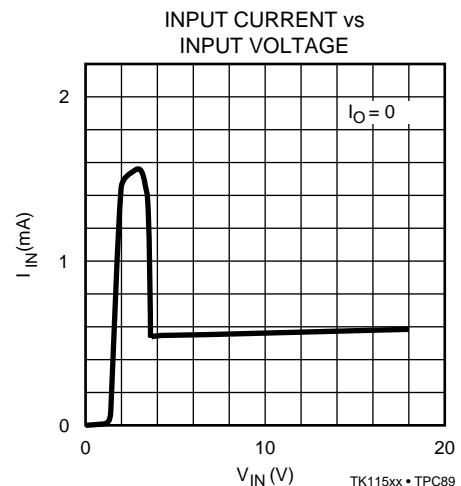
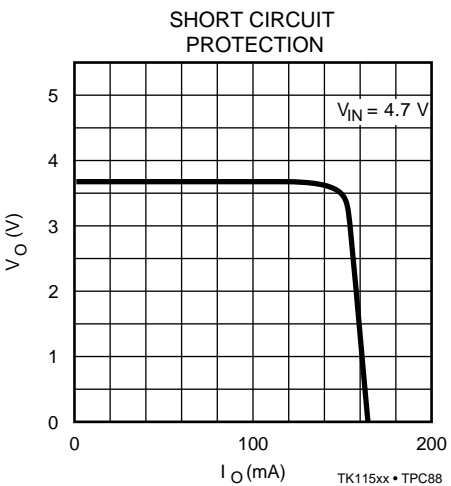
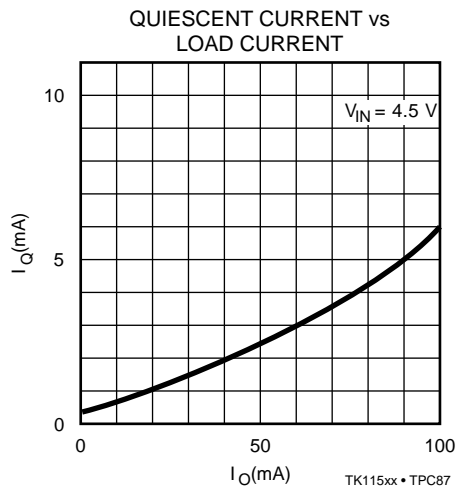
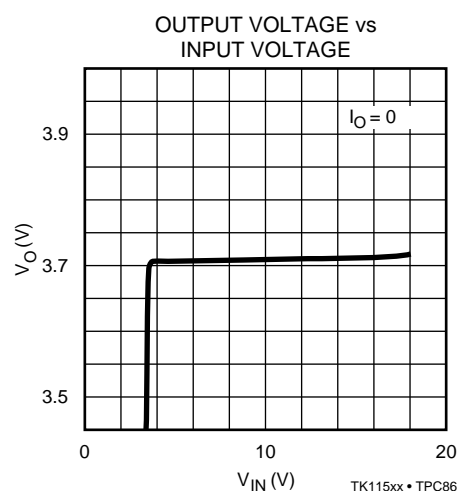
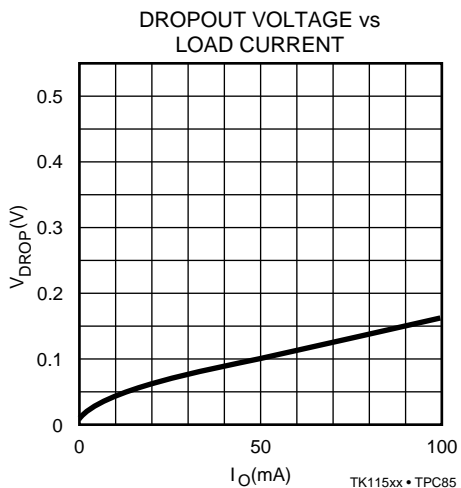
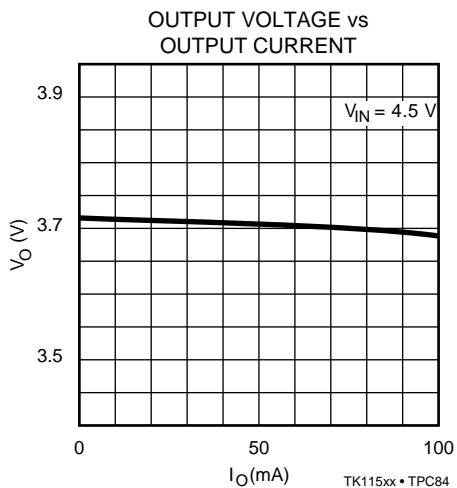

# TK115xx

## TYPICAL PERFORMANCE CHARACTERISTICS (CONT.)

TK11540

$T_A = 25\text{ }^\circ\text{C}$  unless otherwise specified

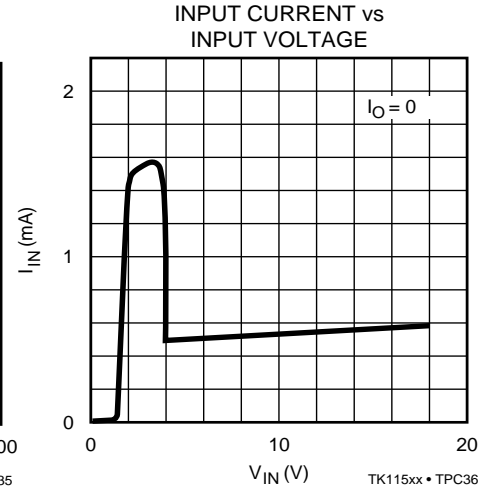
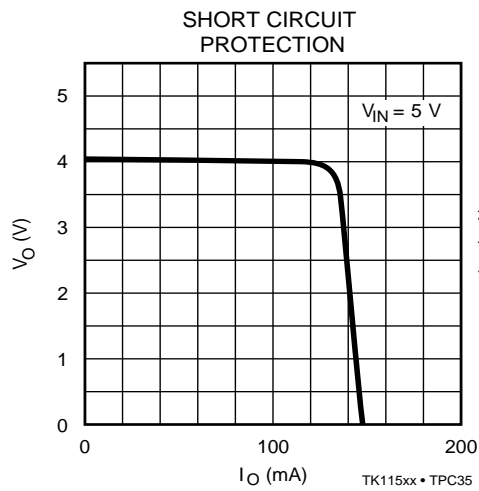
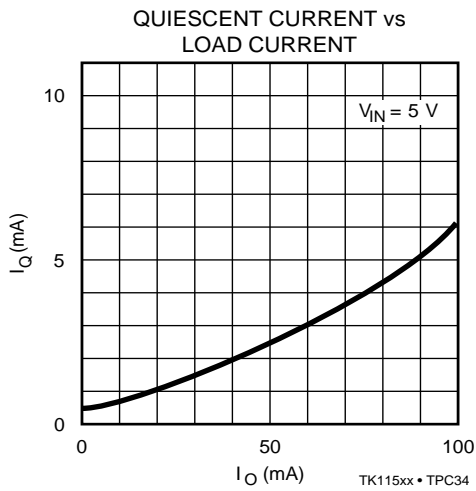
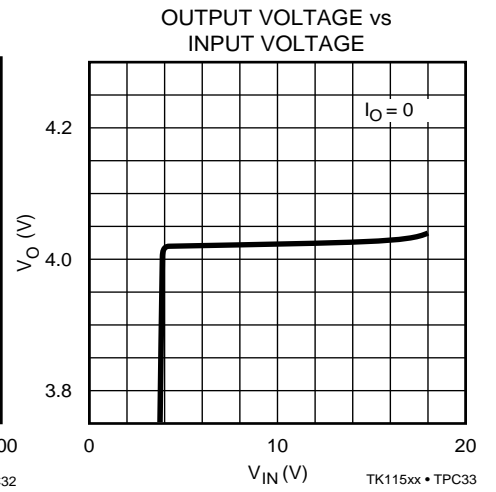
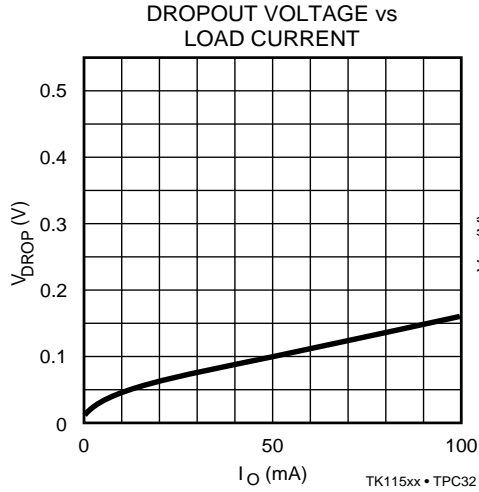
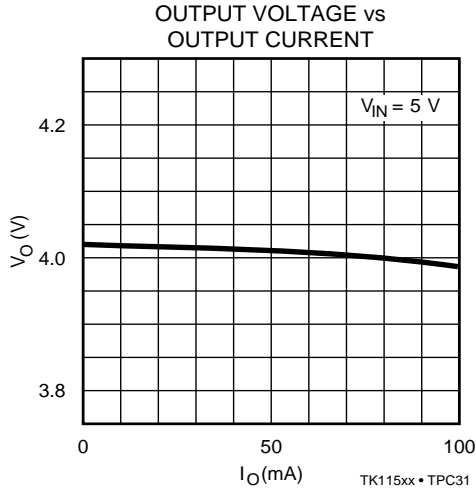

TK11545

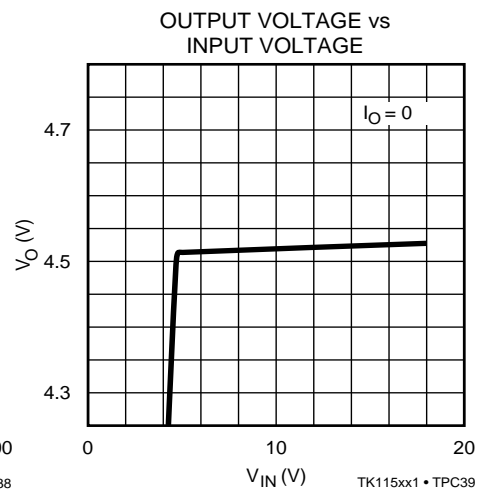
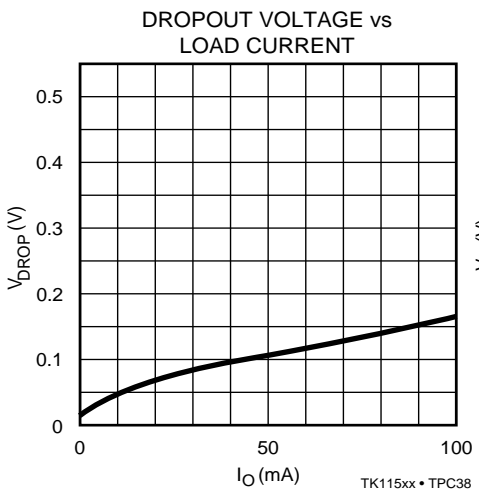
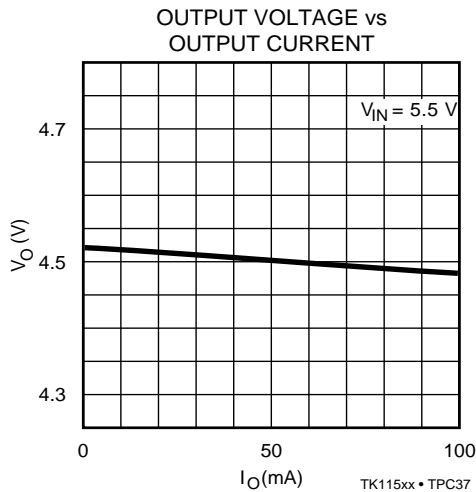

TYPICAL PERFORMANCE CHARACTERISTICS (CONT.)

TK11545 (CONT.)

$T_A = 25\text{ }^\circ\text{C}$  unless otherwise specified

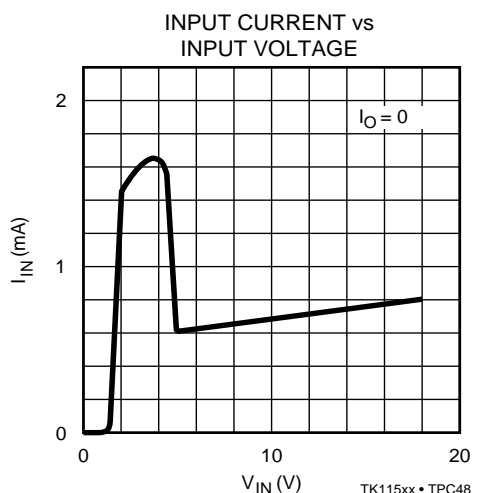
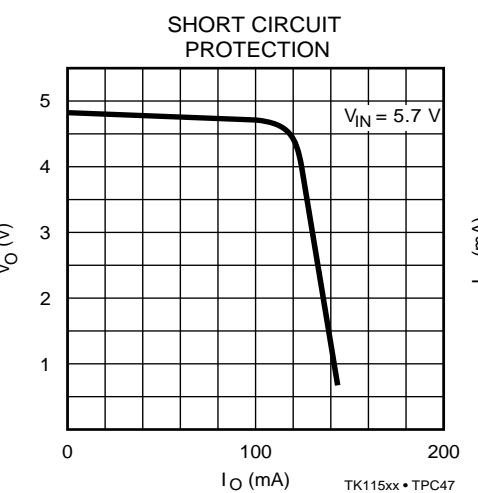
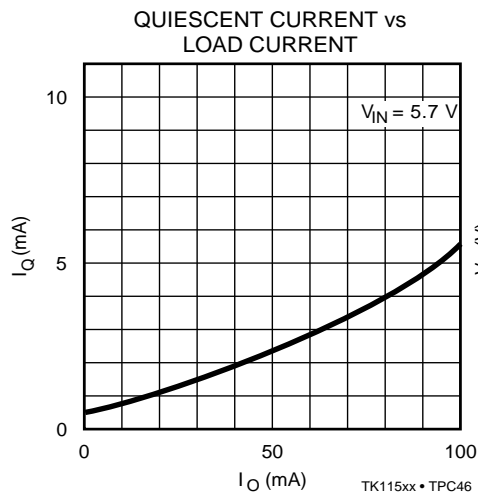
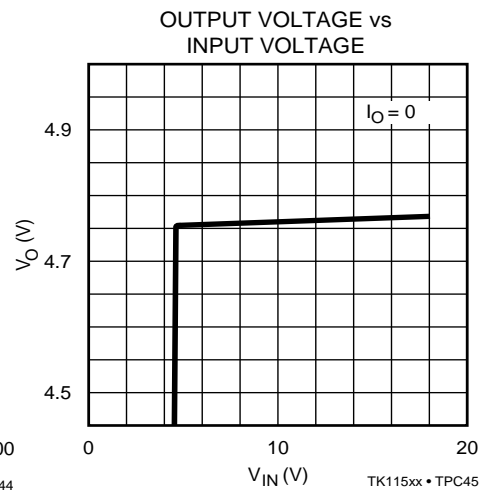
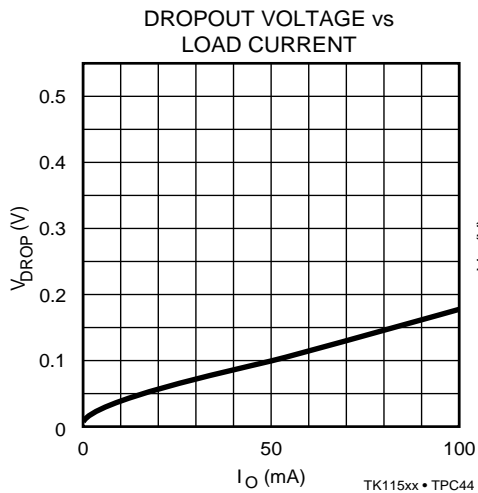
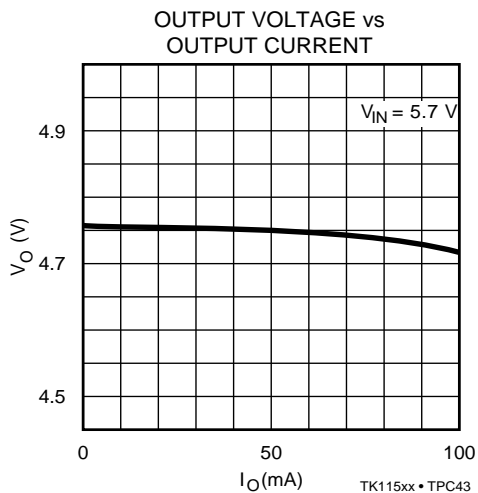
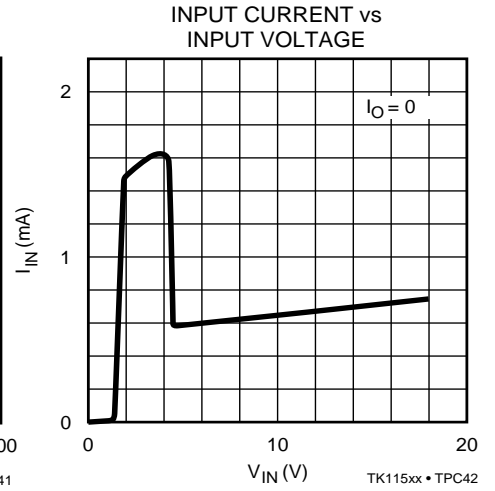
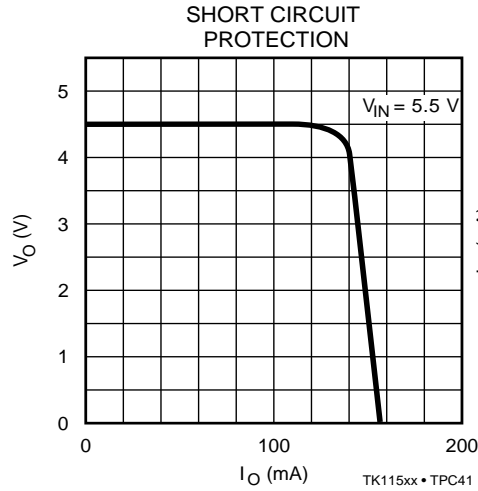
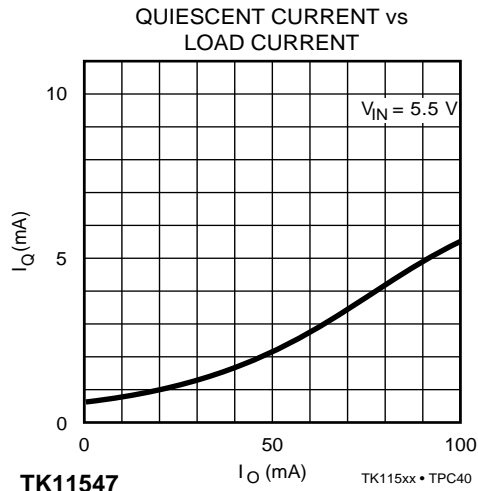

# TK115xx

## TYPICAL PERFORMANCE CHARACTERISTICS (CONT.)

TK11550

$T_A = 25\text{ }^\circ\text{C}$  unless otherwise specified

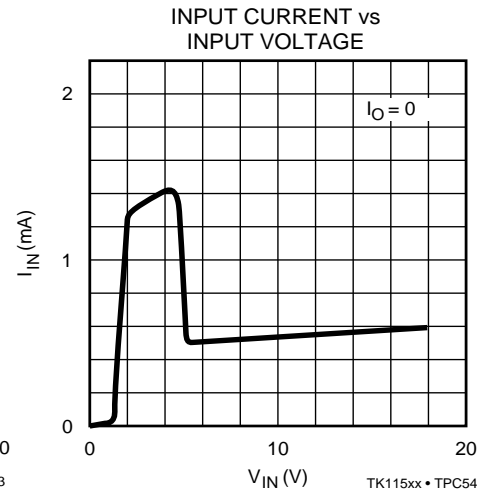
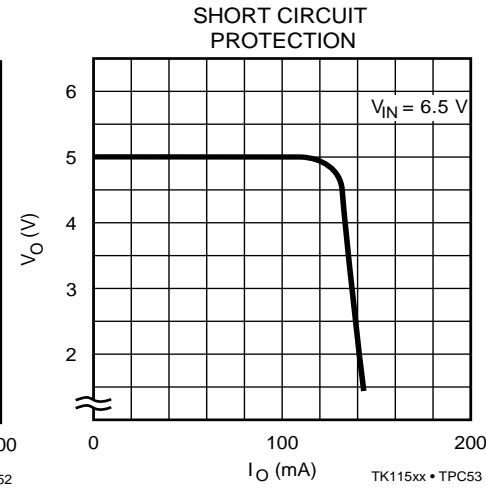
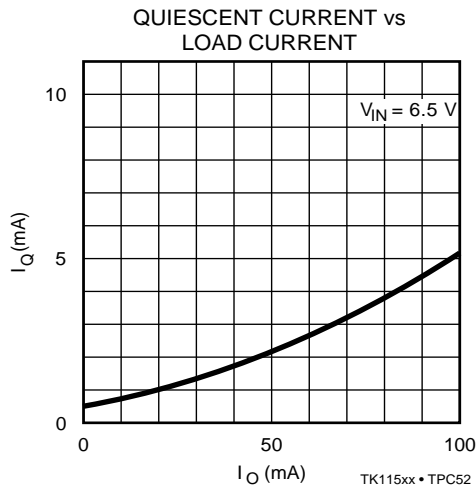
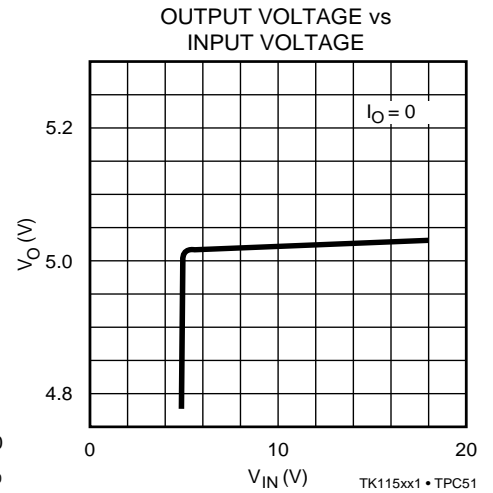
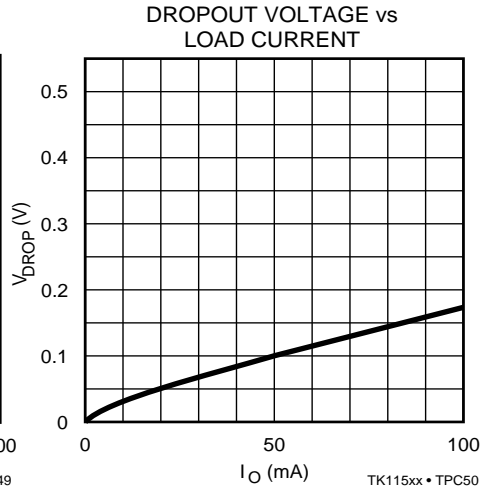
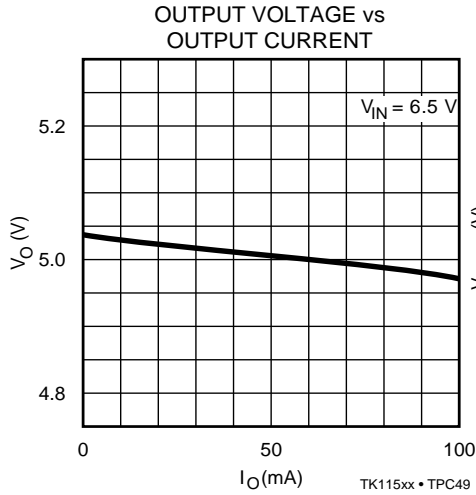

TK11555

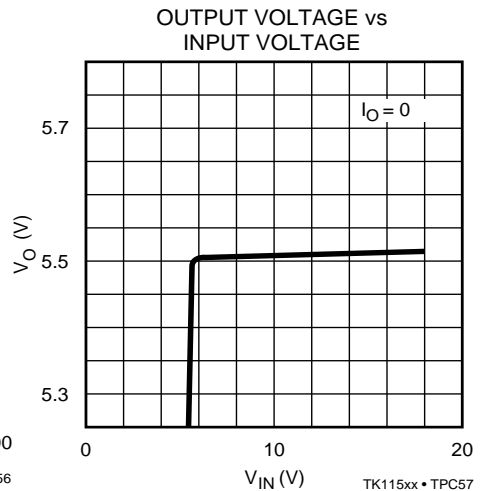
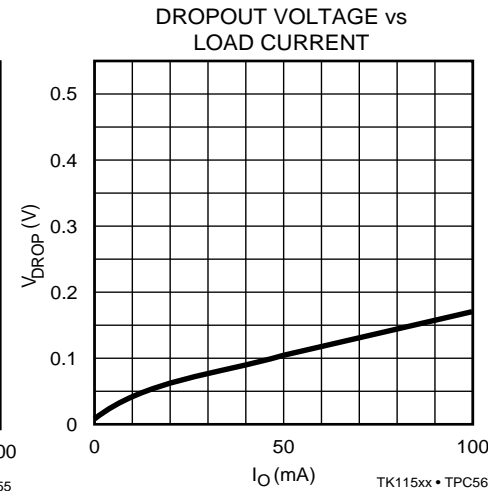
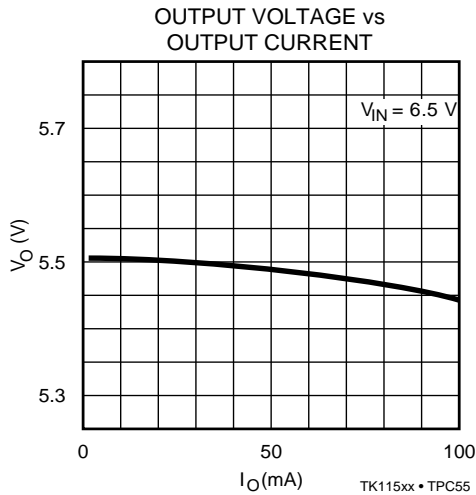

## TYPICAL PERFORMANCE CHARACTERISTICS (CONT.)

TK11555 (CONT.)

$T_A = 25^\circ\text{C}$  unless otherwise specified

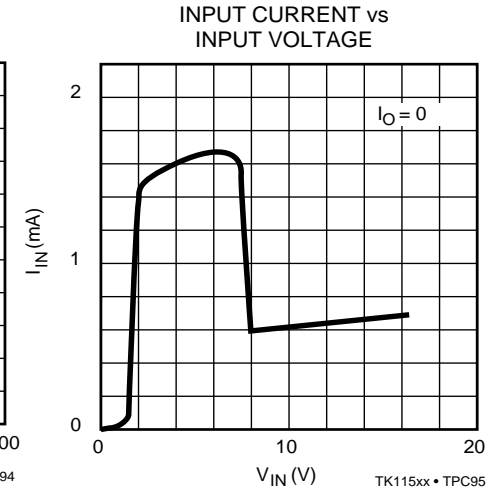
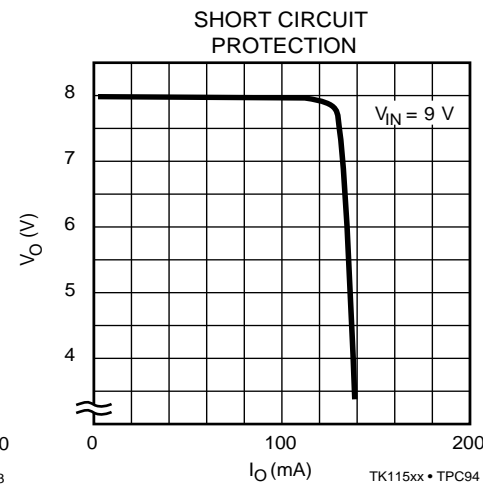
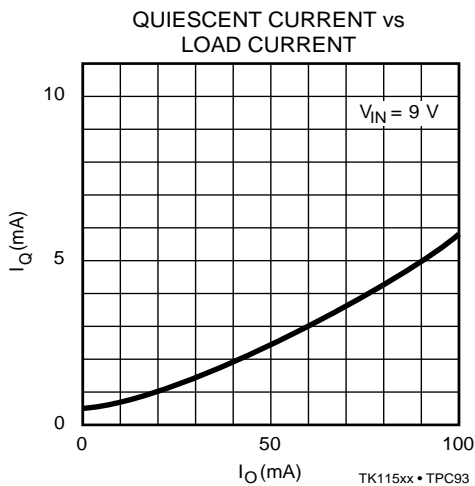
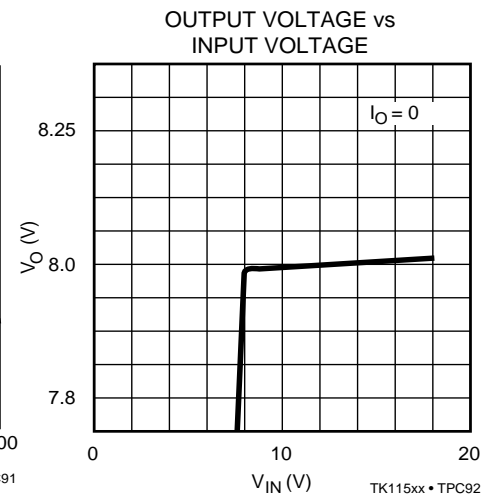
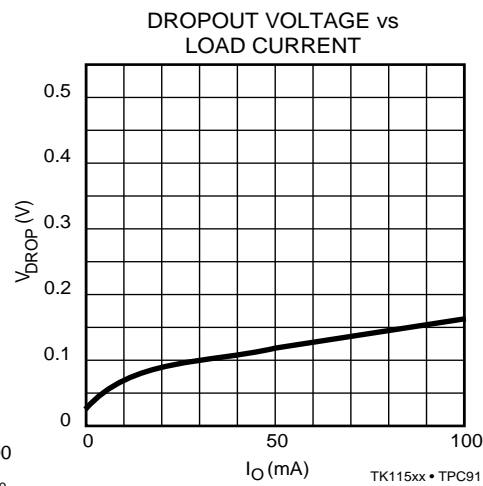
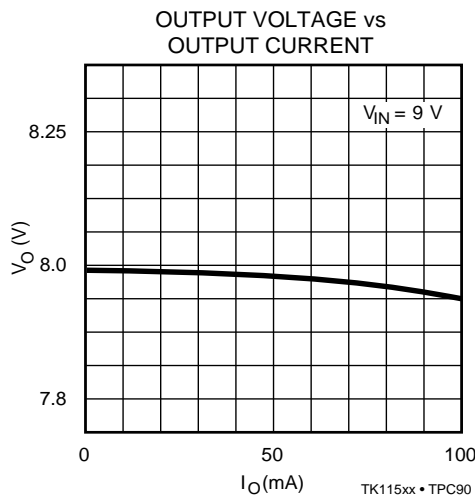
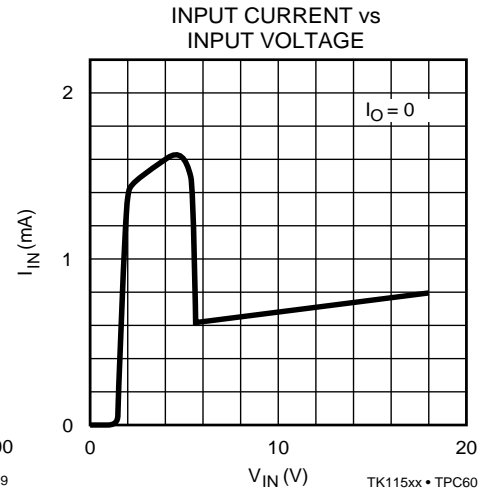
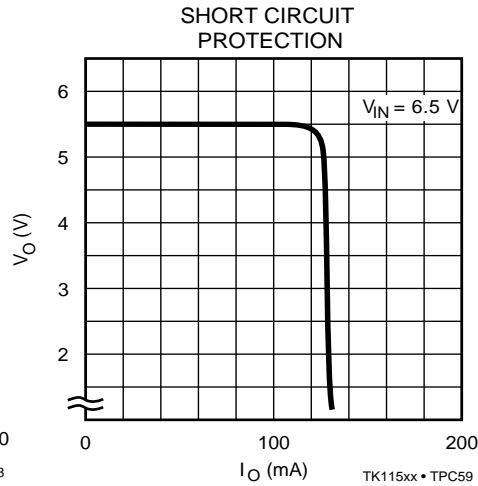
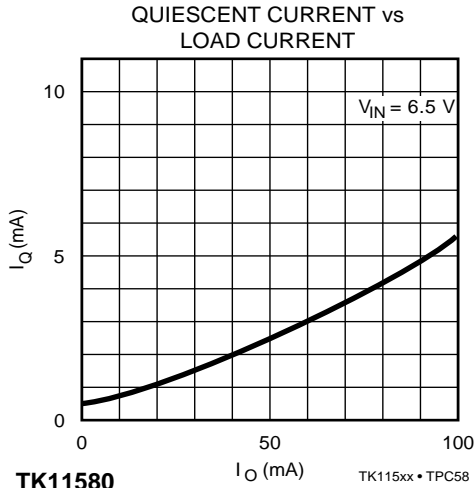

TYPICAL APPLICATIONS

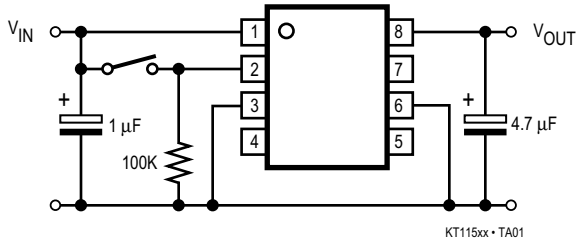

ACTIVE HIGH CONTROL

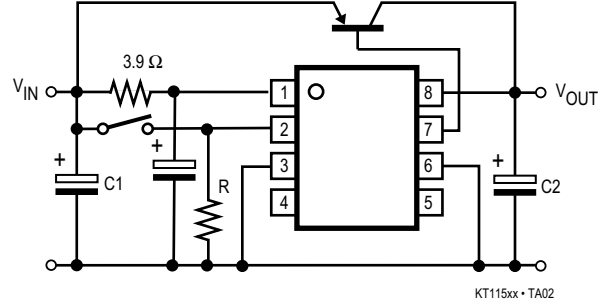

ACTIVE HIGH CONTROL WITH CURRENT BOOST

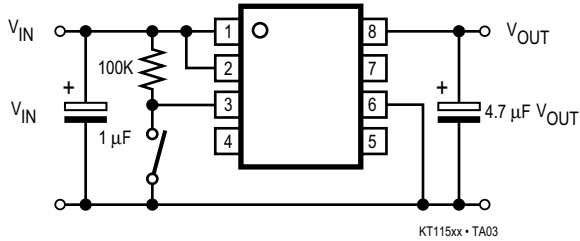

ACTIVE LOW CONTROL

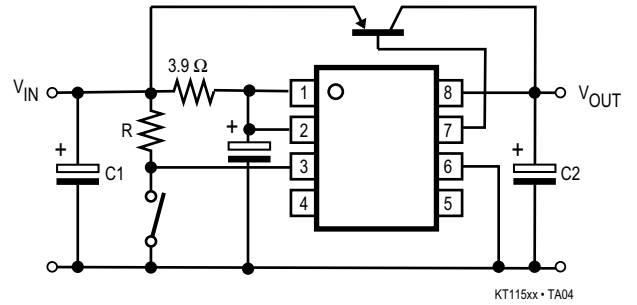

ACTIVE LOW CONTROL WITH CURRENT BOOST

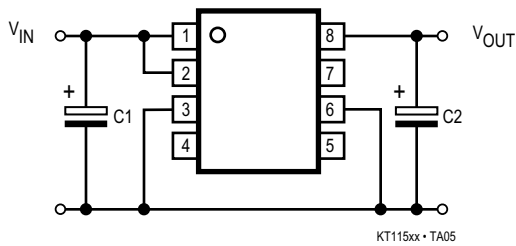

NO SWITCH CONTROL

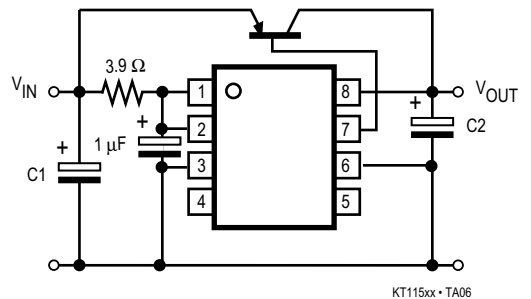

NO SWITCH CONTROL WITH CURRENT BOOST



## TYPICAL APPLICATIONS (CONT.)

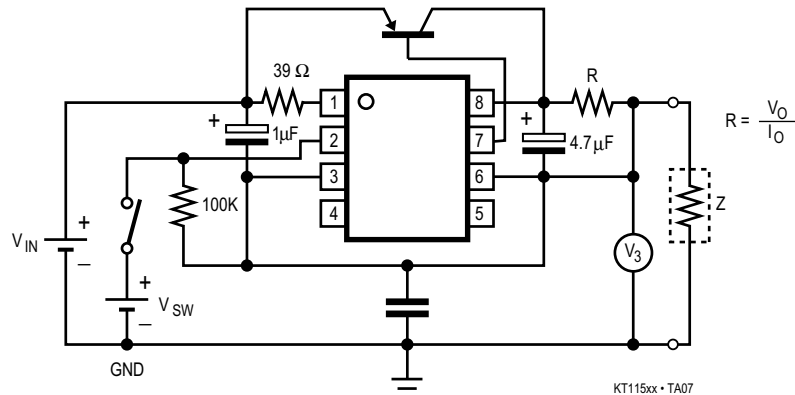

CURRENT MODE REGULATOR WITH ON/OFF CONTROL AND CURRENT BOOST

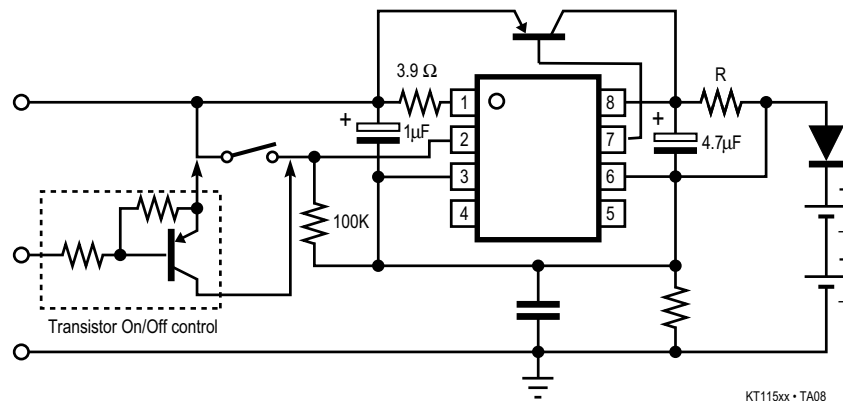

BATTERY CHARGER WITH ON/OFF CONTROL AND CURRENT BOOST

## APPLICATION HINTS

Maximize copper foil area connecting to all IC pins for optimum performance. Place input and output bypass capacitors close to the GND pin. For best transient behavior and lowest output impedance, use as large a capacitor value as possible. The temperature coefficient of the capacitance and Equivalent Series Resistance

(ESR) should be taken into account. These parameters can influence power supply noise and ripple rejection. In extreme cases, oscillation may occur. In order to maintain stability, the output bypass capacitor value should be minimum 1 µF for Tantalum electrolytic or 4.7 µF for Aluminum electrolytic at  $T_A = 25\text{ }^\circ\text{C}$ .

